

MS-60 Portable Leak Detector



Operation/Maintenance Manual

Vacuum Instrument Corporation
Advanced Leak Metrology Division
2099 Ninth Avenue - Ronkonkoma, New York 11779
Tel. 631 737 0900 Fax. 631 737 1541
E-Mail: vicsales@vicleakdetection.com
WebSite: www.vicleakdetection.com

P/N 1109-197-00
Rev. -

Table Of Contents

PORTABLE AUTOMATIC LEAK DETECTOR..... 1

OPERATIONS AND MAINTENANCE
MANUAL.....

CHAPTER ONE - GENERAL INFORMATION..... 1

1.1 INTRODUCTION.....

1.2 UNPACKING & INSPECTION

1.3 INSTALLATION

1.4 FEATURES & SPECIFICATIONS

1.5 GENERAL DESCRIPTION

CHAPTER TWO - OPERATING THE MS-60 1

2.1 INTRODUCTION

2.2 OPERATOR CONTROLS & INDICATORS

2.3 STARTING THE MS-60 LEAK DETECTOR.....

2.4 LEAK TESTING.....

2.5 SHUT DOWN PROCEDURE

2.6 SETTING TEST PARAMETERS.....

2.7 SETTING ADDITIONAL PARAMETERS

2.8 TEST AIDS & PROCEDURES.....

CHAPTER THREE - THEORY OF OPERATION 1

3.1 INTRODUCTION TO LEAK DETECTION THEORY.....

3.2 DIRECT FLOW & REVERSE FLOW MODES

3.3 FUNCTIONAL DESCRIPTION OF OPERATION.....

3.4 DESCRIPTION OF MAJOR COMPONENTS.....

CHAPTER FOUR - SERVICE & MAINTENANCE 1

4.1 INTRODUCTION.....

4.2 SERVICE MODE

4.3 CALIBRATION & TUNING

4.4 PERIODIC SERVICE.....

4.5 CONTAMINATION OF THE VACUUM SYSTEM.....

4.6 VENTING THE VACUUM SYSTEM.....

4.7 CLEANING REQUIREMENTS.....

4.8 CALIBRATION REQUIREMENTS

4.9 GENERAL SERVICE & REPAIR.....

4.10 TROUBLESHOOTING AIDS.....

CHAPTER FIVE - PARTS LIST 1

5.1 INTRODUCTION

5.2 RECOMMENDED SPARE PARTS FOR THE MS-60

5.3 BILL OF MATERIAL.....

Appendix A:

Glossary of Terms Used in Leak Detection

Appendix B:

A.V.S. Standards for Testing of Mass Spectrometer Leak Detectors

Appendix C:

Leakage Conversion Factors

Appendix D:

Remote Port Specifications

Appendix E:

Profile and Revision Switch Positions

Appendix F:

MS-60 Quick Reference

General Information

1.1 INTRODUCTION

This Operation/Maintenance Manual describes in detail the information needed to understand the operation and functions of the Vacuum Instrument Corporation (VIC) MS-60 Fully Automatic Portable Leak Detector. This manual has been divided into five chapters:

- **Chapter 1** General Information
- **Chapter 2** Operating the MS-60
- **Chapter 3** Theory of Operation
- **Chapter 4** Service & Maintenance
- **Chapter 5** Parts List

Chapter 1, General Information, describes unpacking and inspection of the unit, installation requirements, the features and specifications of the MS-60 Leak Detector and its basic operation.

Chapter 2, Operating the MS-60, details the controls necessary to operate the MS-60, both during normal operation of the unit as well as when placed in Service Mode. All external connectors and their applicability to the unit and its functions are also discussed. This chapter also includes an explanation of what occurs during the unit's start-up procedure, a description of the leak test modes, an explanation of sniff testing procedures, a step-by-step description of how to perform actual leak testing, operations involving the optional external pump, an explanation of what occurs during the unit's shutdown procedure, the setting of the unit's testing parameters, and MS-60 self-testing procedures.

Chapter 3, Theory of Operation, has been included in order to give the MS-60 user information on how the unit functions. Maintenance personnel servicing the unit will find this most useful, since a thorough technical understanding of how the unit operates is critical when performing the repairs and service discussed in the following chapter.

Chapter 4, Service & Maintenance, describes in further detail the unit's Service Mode, the necessary tuning/calibration procedures for the MS-60, required periodic service procedures and recommended service intervals, detection and correction of contamination within the vacuum system, procedures for venting the vacuum system, cleaning requirements and procedures, calibration of measurement components, valve block service and repair, repair/replacement of the unit's electronics and a full listing of front panel error codes, their probable causes and our recommended corrective actions.

Chapter 5, MS-60 Parts Lists, contains a full list of recommended spare parts and a bill of material listing.

1.2 UNPACKING & INSPECTION

Unpack the MS-60 immediately after delivery to insure all parts are present and the unit is free of damage.

Examine the shipping carton for signs of damage. If damage is discovered, immediately file a claim with the shipping carrier. If the damaged part requires replacement, please contact the VIC customer service department.

Retain the shipping carton and packaging material in the event the unit must be returned. Please note that VIC must be contacted before returning any equipment.

Once the leak detector has been removed from its package, the MS-60 must be opened and the internal pumps shipping bracket removed and pump filled with oil. To do this the back cover is first removed and then shipping bracket is removed. Please hold on to the shipping bracket in case the unit must be returned to VIC.



Cover Removal (Straight Blade Screwdriver Required)

- 4 spring lock screws (2 on the side and 2 in the back) are to be loosened.
- Pull cover up to remove.

WARNING

Only qualified service personnel should operate the unit when either the front or rear panels are open. Potentially lethal high voltages are continually applied to the circuit boards and other areas within the unit during its operation. Although these areas are shielded and well marked, failure to follow this precaution may possibly lead to severe injury or death.





Shipping Bracket VIC P/N 464-021-0023 Removal (7/16" or Adjustable Wrench Required)

- Loosen and remove the 2 screws holding the shipping bracket.
- Please keep the shipping bracket with the original packaging materials in case the unit must be returned to VIC for repair.



WARNING

The pump is shipped without oil. Do not start unit until the proper level of oil is installed into the pump.

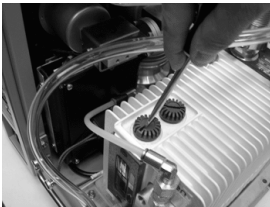

Oil Fill (Straight Blade Screwdriver, Funnel & Oil Required)

- To fill the pump with oil, unscrew the black cap on the pump as shown.
- Using the oil (760-54-001) and the funnel (1331-191-00) provided in the installation kit, slowly fill the pump until the level in the sight glass is approximately in the middle of the white bar.
- Replace the black oil fill cap.

When the shipping bracket has been removed and the pump has been filled with oil, replace the MS-60 cover panel.

An Installation Kit (VIC P/N 0142-800-00) is included with the unit when it is shipped. The kit contains:

Part Number	Description
0103-141-01	Filament Kit (box of 5)
1330-129-00	Funnel
1330-391-00	7/64 Allen Wrench
760-54-001	Oil, Inland 45
282-111-2004	Connector, 4 position
282-111-2006	Connector, 6 position
282-111-2010	Connector, 10 position
1621-227-05	QC Adapter, KF25 to 1 1/8"
0126-284-00	Blank Plug, 1/18

1.3 INSTALLATION

The MS-60 has been designed as a completely self-contained portable leak detector and therefore has the capability to work in a wide range of environments. However, before installation in a work area, be certain requirements must be met.

- A properly grounded electrical supply (115V/60Hz/10A, 230-240V/50Hz/5A, 100V/50Hz/10A, or 100V/60Hz/10A as labeled on rear of unit) must be available for the unit.



- A user supplied helium supply is usually necessary for the unit (but not for all testing, e.g., sealed parts should already be pre-bombed with helium). The MS-60 can use either a Mass 3 or Mass 4 helium supply. Virtually any standard purity helium may be used during leak testing. Depending on the type of leak testing that will be performed, a spray probe (for vacuum testing), a sniffer assembly (for sniff testing) or a test cup (for pressure bombing testing) will be necessary. All of these items are available directly from VIC.
- The recommended ambient temperature range for the unit is from 10°C to 40°C. Also, excessively humid environments should be avoided.
- Depending upon the immediate environment, an external exhaust facility may be necessary. A bulkhead is installed on the rear of the MS-60 that is intended for user-provided 3/8" Polyflow tubing is then attached to a functional exhaust system.

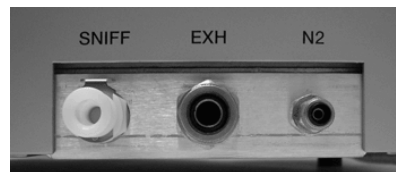

1.4 FEATURES & SPECIFICATIONS

FEATURES

Sensitivity	5 x 10 ⁻¹² std cc/sec air equivalent
Leak Rate Range	<ul style="list-style-type: none"> ● 10 to 5 x 10⁻¹² std cc/sec air equivalent (with optional external pump) ● 10 x 10⁻⁵ to 5 x 10⁻¹² std cc/sec air equivalent (without external pump)
Start-Up	Fully functional in less than 3 minutes. Consists of: Turbomolecular pump acceleration, a complete set of self-diagnostics, turning on filament, checking and assuring Hi-Vac status, measuring system offsets and measuring background helium.
Internal Calibrator	Helium 4, 1 x 10 ⁻⁸ to 3 x 10 ⁻⁸ std cc/sec air equivalent with integral solenoid valve
Testable Masses	Helium Mass 3 or 4
Tuning	Automatic
Calibration	Automatic for Helium 4 using an internal calibrator of 1 x 10 ⁻⁸ to 3 x 10 ⁻⁸ std cc/sec air equivalent. Semi-automatic using an external calibrator.
Auto Zero	AZ ³ zero modes - Normal, Spray and Hold
Background Compensation	Continuous automatic compensation for system back ground
Remote Control Unit	Molded A.B.S. plastic laminate over tactile membrane switch array Controls similar to User Panel
RS-232C Port	Two standard bi-directional ports. One port dedicated to the remote control unit. The second port is dedicated to data transfer to an external computer or control module
External Calibration	Machine calibration through external calibrator mounted on top test port
Password Security	Password required to access critical machine functions
Digital I/O Ports	Digital input and output ports available
Ranging Automatic/Standard Mode	Without an external roughing pump, testing begins at the least sensitive gross range (10 ⁻⁵). The unit ranges downward until a leak is detected or until it reaches its most sensitive range (10 ⁻¹²). With the optional external pump, if a gross leak is detected, the unit ranges up to the appropriate decade. If a gross leak is not detected the unit ranges downward until a leak is detected or until it reaches its most sensitive range.
Ranging Manual Mode	May operate at any range, selectable by the operator. The 10 ⁻¹ to 10 ⁻⁴ range is only available when the optional external pump has been installed.
Measurement Units	<ul style="list-style-type: none"> ● Pressure - millitorr, millibar, or hPa ● Leak Rate - std cc/sec (standard cubic centimeters/second), mbar l/sec (millibar liters/second) or PaM³/Sec.

PUMPS

Mechanical Pump	Internal 7.0 or 10.6 CFM dual stage rotary vane pump
Turbo Pump	60 liter/second turbomolecular pump
External Pump (optional)	16 CFM dual stage rotary vane pump

PERFORMANCE SPECIFICATIONS

Sensitivity	<ul style="list-style-type: none"> ● 5×10^{-12} Std cc/sec air equivalent (direct mode) ● 5×10^{-10} Std cc/sec air equivalent (reverse mode)
Resolution	14 at Mass 4
Response Time	<ul style="list-style-type: none"> ● Reverse Mode < 3 seconds ● Fine Mode < 2 seconds
Test Time	<2.5 seconds on a blank port to a pre-selected range in the reverse flow test mode
Electronic Response Time	<0.5 seconds
Noise & Drift	<5% on 10^{-11} range
Testable Masses	3 and 4
Maximum Measurable Leak	10×10^{-5} std cc/sec air equivalent (without external pump) 10 std cc/sec air equivalent (with optional external pump)
Maximum Inlet Pressure	<ul style="list-style-type: none"> ● Gross Mode - Atm (with optional external pump) ● Reverse Mode - 7.5 Torr ● Direct Mode - 100 mTorr
Test Mode Leak	<ul style="list-style-type: none"> ● Gross: 10 to 1×10^{-4} std cc/sec helium ● Reverse: 10×10^{-5} to 6×10^{-10} or 10×10^{-3} to 3×10^{-9} ● Direct: 10×10^{-6} to 5×10^{-12}

ELECTRONICS & USER INTERFACE

System Controller	Microprocessor based; four integrated boards used
A Board	Controls the unit's computer, logic and sensors
B Board	Controls the unit's mass spectrometer voltage supplies
C Board	Controls the unit's displays and controls
Power Dist. Board	Distributes power throughout the unit
Remote Board	Controls the unit's optional handheld remote
Display	Green LED alphanumeric and bar graph displays
Data Input	Through dedicated function keys

MISCELLANEOUS

Power Requirements	<ul style="list-style-type: none"> ● 115V, 60Hz, 10 Amp ● 230-240V, 50Hz, 5 Amp ● 100V, 50Hz, 10 Amp ● 100V, 60Hz, 10 Amp
Dimensions	15.5"H x 20.5"W x 14.25"D
Weight	<ul style="list-style-type: none"> ● w/7 CFM pump - 100 lbs. ● w/10 CFM pump - 130 lbs.

1.5 GENERAL DESCRIPTION

The MS-60 is a fully automatic, dual mode, turbomolecular pumped portable leak detector. Each of its two modes (Reverse Flow or Direct Flow) is automatically selected by the leak detector based on the currently selected leak rate range.

Reverse Flow Mode permits rapid testing for leaks in test objects that are characterized by a high degree of out-gassing. Testing can start at test port pressures of Atm for leaks from 10 to 1×10^{-4} std cc/sec (Gross Mode testing) when using the optional external pump or pressures of 7.5 Torr for leaks between 10×10^{-5} and 6×10^{-11} std cc/sec (Intermediate Mode testing) for units not equipped with an external pump.

Direct Flow Mode is most useful for testing objects that demand clean testing and higher sensitivity. In this mode, the leak detector measures leaks from 10×10^{-9} to 5×10^{-12} std cc/sec, at a test port pressure of 100 millitorr or less. However, this mode is also capable of determining larger leaks. Once the unit is in this mode and a larger leak has been detected, the unit will range back to the appropriate decade.

Standard Operation

This is the normal operating mode for the MS-60. During operation, the User need only use the right (uncovered) portion of the display panel. All functions to be accessed and display information needed to leak test an object are found on this panel. The panel displays bar graphs indicating leak rate values with unit indicator and test port pressure with unit indicator. Additionally, the panel indicates the current leak range mode, an accept/reject indicator that indicates if the leak being tested is above or below the test set point. The user panel also has toggles for automatic or manual ranging (including greater/lesser pushbuttons), audio volume pushbuttons, an auto-zero pushbutton, a sniff mode indicator and ready indicator when the unit is ready for testing along with START and VENT pushbuttons (START is used to commence the testing cycle as well as to interrupt the testing cycle without the chance of accidentally venting the system, while VENT is used to interrupt testing and/or to vent the test port).



Service Mode

WARNING

The Service mode of the MS-60 is intended for use by qualified VIC personnel or Users specifically trained by VIC. Under no circumstances should any individual be assigned access to this mode without a complete knowledge of vacuum systems as well as the MS-60 System. Use by an unqualified operator may result in damage to the unit and/or personal injury.

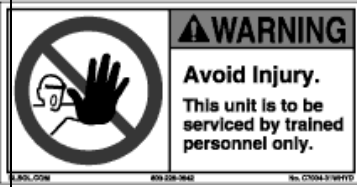

WARNING

Only qualified service personnel should operate the unit when either the front or rear panels are open. Potentially lethal high voltages are continually applied to the circuit boards and other areas within the unit during its operation. Although these areas are shielded and well marked, failure to follow this precaution may possibly lead to severe injury or death.



Service mode is initiated by first opening the front panel of the unit (loosen the two 1/4 turn screw at the top of the panel, then gently lower the door), and then pressing the blue pushbutton (SW1) on the A Board.



Once the pushbutton has been pressed, the unit is placed in Service mode and the Service mode indicator is illuminated.

Service mode disables the automatic valve controls and allows the User to manually control all of the valves within the vacuum system. The valves are controlled by a cluster of labeled momentary switches located on the left of the User Panel. The LED indicator on each switch is lit when the valve is open. The valves included within the vacuum system are: cal (calibrator), ext rough (external rough), direct (fine), fore (foreline or reverse), gross, purge, rough, sniff and the vent.

Operating The MS-60

2.1 INTRODUCTION

This chapter contains the information needed by the user to operate the MS-60 Leak Detector and perform leak checks on a test object. This chapter is grouped into three general sections:

1. Operator Controls & Indicators
2. Starting & Operating the Leak Detector
3. Testing Aids & Procedures

While this chapter contains sufficient information to operate the MS-60 leak detector, we suggest that you read Chapter 3, **Theory of Operation**, prior to any actual testing. An overall understanding of the various phases of a test cycle will help the operator use the leak detector more effectively and efficiently.



MS-60 User Panel

2.2 OPERATOR CONTROLS & INDICATORS

The following Controls & Indicators are located on the User Panel at the top right front of the unit.

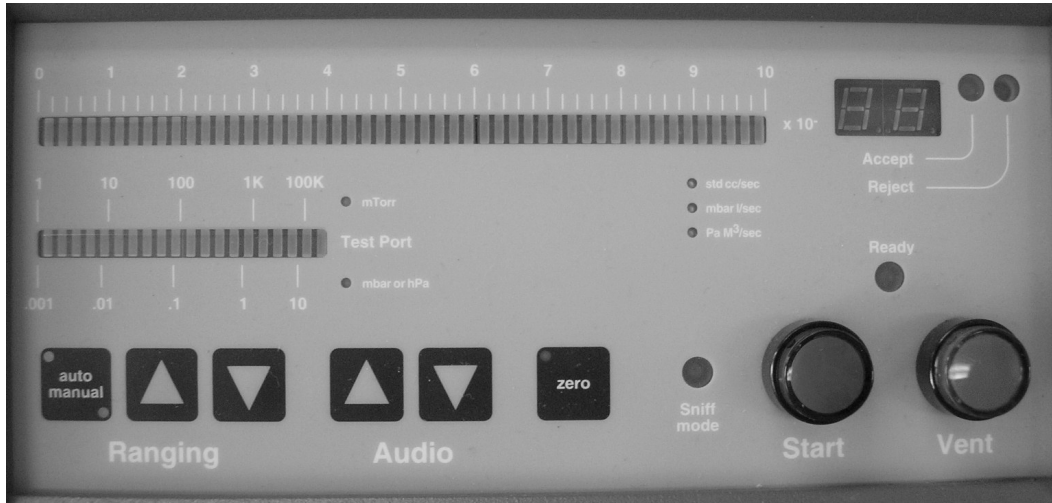

LEAK RATE BAR GRAPH

An LED bar graph indicating the mantissa of the measured leak rate of the test object. For a full leak rate reading, this meter is used in conjunction with the Numeric Display. The bar graph display is in standard cubic centimeters per second (std cc/sec), or in millibar liters per second (mBar l/sec) or Pascal meters cubed per second (PaM³/Sec). The leak rate can also be displayed in digital format on the Service Panel alphanumeric display.

NUMERIC EXPONENT DISPLAY

A two-digit alphanumeric display that has two separate functions. During testing, the display will normally indicate the exponent of the current leak rate. For example, if the leak rate is 3×10^{-7} std cc/sec, the Leak Rate Bar Graph will indicate **3** while the Numeric Display will indicate the number **7**. The second function of the display has been programmed to provide error codes when a system fault has occurred (see Section 4.10 for a list of error codes, their description and corrective action). The display will indicate code **EE** while at the same time on the Service Panel the Error Code indicator will be lit and the Service Panel alphanumeric display will indicate the error code.

ACCEPT

During leak testing, this indicator will illuminate when the leak measured is less than the programmed reject rate (or maximum acceptable leak rate) and the unit is also in or below the range of the reject value. The reject rate is set by the user from the Service Panel (see Section 2.6).



REJECT

During leak testing, this indicator will illuminate when the leak measured is greater than or equal to the programmed reject rate (or maximum acceptable leak rate). The reject rate is set by the user from the Service Panel (see Section 2.6).

std cc/sec, mbar l/sec, Pa M³/sec

Light indicator for selected leak rate designation.

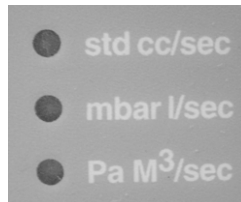
**TEST PORT**

A bar graph that displays the pressure at the test port. Scaled for either mTorr (millitorr), mbar (millibar) or hPa (hecto Pascals). The test port pressure can also be displayed in digital format on the Service Panel Alphanumeric Display.

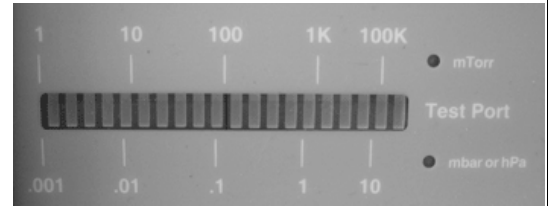
**AUTO/MANUAL**

Automatic/Manual Ranging. Prior to and during leak testing, this momentary switch allows the user to toggle between Automatic and Manual Ranging modes.

**RANGING**

While leak testing in Manual Ranging mode, each press of either the up or down arrow buttons will cause the unit to leak test in the decade (or range) above or below the current decade being tested (pressing and holding either arrow button will cause the unit to sequentially pass through one or more decades). The numeric display (the exponent of the leak rate) will indicate the change. Also, when leak testing in the automatic ranging mode, pressing either arrow button will force the unit to test in manual ranging mode, at a decade higher or lower than the decade previously being tested (corresponding to the arrow key pressed).

AUDIO

During actual testing and while in service mode, the audio signal of the unit is always turned on. The arrow keys dedicated to the Audio section of the panel control the volume. Pressing the down arrow key several times (or pressing and holding the down arrow key) reduces the volume to an inaudible level. Note that this function is also available when using the optional headset. A connector for the headset is located on the right side of the unit.

**ZERO (AZ³™ ZERO MODES)**

There are 3 Modes of Zero - Normal, Spray, and Hold Modes. Refer to section 2.8 for further detailed explanation.

In Standard mode, the ZERO momentary switch is active only during actual leak testing. When pressed, the MS-60 computer reduces the measured leak rate displayed by the unit.



To zero within the decade being measured (e.g., a 4×10^{-6} std cc/sec leak rate would now be displayed as a 0×10^{-6} std cc/sec leak rate). This function is usually used when background helium causes measurement problems during testing. Note that this function also limits the maximum sensitivity of testing to two decades (or ranges) below the zeroed decade. When the unit is in Service Mode, pressing the ZERO momentary switch will toggle the turbomolecular pump on or off. When the ZERO LED indicator is lit, the turbomolecular pump is on.

SNIFF MODE INDICATOR

When lit, the unit has been placed in the Sniff mode. When in Standard mode, the unit is placed in the Sniff mode by pressing the SNIFF valve momentary switch located on the left of the Service Panel. When the unit has been placed in Service Mode, pressing the SNIFF valve momentary switch opens the Sniffer Valve.

**WARNING**

Never operate the MS-60 in Sniff Mode without the optional Sniffer Assembly or without the standard plug in place on the Sniffer Quick Connect Fitting (QCF). Running the unit without covering the Sniffer QCF will cause a dramatic increase in foreline pressure within the unit, and will thereby cause the unit's turbo-molecular pump to rapidly shutdown.

START

Pressing this pushbutton begins a test cycle. During testing, pressing the START pushbutton again will halt all testing by closing all vacuum system valves (except the foreline valve). This also places the unit into its **standby** (wait) mode. Pressing the START pushbutton instead of the VENT pushbutton eliminates the chance of the user inadvertently venting the system (refer to the VENT function, below). The START pushbutton lights when a test cycle has been initiated.

**VENT**

Dual function pushbutton. When pressed momentarily, the MS-60 is interrupted from its current testing cycle and placed in **standby** (wait) mode. The green READY indicator will light. When pressed and held for a preprogrammed time (as programmed by the user; factory default is 0.5 second) the pushbutton initiates an AUTO-VENT cycle and returns the test port to atmospheric pressure. The delay may be programmed for up to 999.9 seconds.

READY

When lit, the unit is in standby mode (all valves except the foreline valve are closed). Pressing the START pushbutton commences a test cycle.

SERVICE PANEL

The following Controls & Indicators are accessible from the Service Panel (the left half of the panel under the MS-60 Cover.).

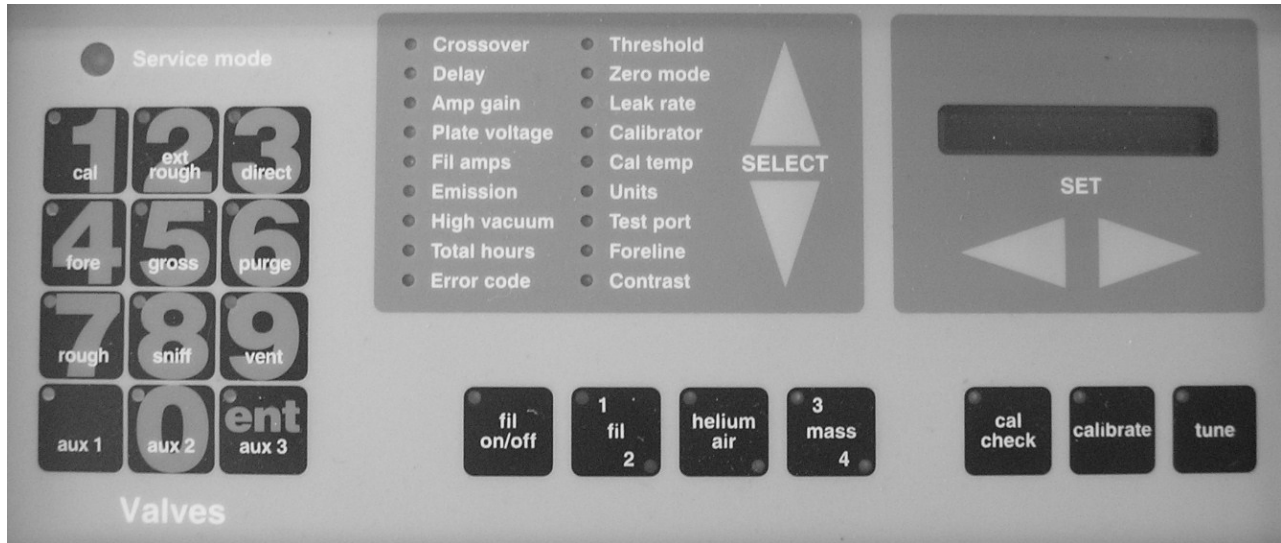

SERVICE MODE INDICATOR

When lit, the MS-60 has been placed in Service Mode. The unit is placed in Service Mode by pressing the blue pushbutton (SW1) located on the “A” circuit board, mounted on the inside of the unit’s front door.

Manual Valve Control

- cal - 1 = calibrator valve
- ext rough - 2 = external rough valve
- direct - 3 = direct flow valve
- fore - 4 = foreline valve
- gross - 5 = gross test valve
- purge - 6 = purge valve
- rough - 7 = rough pump valve
- sniff - 8 = sniffer probe valve
- vent - 9 = vent valve
- aux 1 =
- aux 2 - 0 =
- aux 3 - ent =

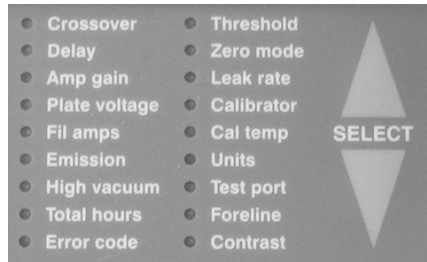

**NOTE**

To make any changes to the parameters in Standard mode, the password feature must be accessed to unlock the machine.

CROSSOVER

Two crossover settings are available and may be set in either Standard or Service mode.

CROSSOVER - R

The alphanumeric display indicates the programmed test port pressure needed to crossover from the unit's gross testing mode to reverse testing mode (when using the optional external pump). If an external pump is not connected to the unit, the crossover set point is the pressure needed to crossover from the unit's roughing mode to the reverse testing mode. This parameter may be altered while the unit is in either Standard or Service mode, by using the SET momentary switches.

CROSSOVER - D

The alphanumeric display indicates the programmed test port pressure needed to crossover from the unit's Reverse testing to its Direct testing mode. This parameter may be altered while the unit is in either Standard or Service mode, by using the SET momentary switches.

DELAY

Seven delay settings are available and may be set while the unit is in Standard mode only:

D1/Fine (Direct) Crossover Delay

The time delay after Crossover D has been reached and the onset of Direct testing. The MS-60 stays in Reverse Flow during this time. The factory default is 2.0 second; the parameter may be set between 2.0 to 999.9 seconds. Note that if the MS-60 is set for Manual ranging in the 10^{-10} range, the unit will remain in the roughing state for the time set in D1 after Crossover D has been reached.

D2/Direct Rough Valve Close Delay

When Crossover D has been reached, the Rough valve will remain open for this value and will then close. The factory default is 1.0 second; the parameter may be set between 1.0 to 999.9 seconds. If D2 is set to 999.9 seconds, the Rough valve will remain open for the entire length of the test cycle.

D3/Vent Delay

The amount of time needed to hold the VENT pushbutton before the venting cycle begins. The factory default is 1.0 seconds; the parameter may be set between 1.0 to 999.9 seconds.

D4/Vent Duration

The amount of time the vent valve will stay open after the unit's Pirani gauge indicates atmosphere has been reached. The factory default is 3.0 second; the parameter may be set between 3.0 to 999.9 seconds. If D4 is set to 999.9 seconds, the Vent valve will remain open until next test cycle is started.

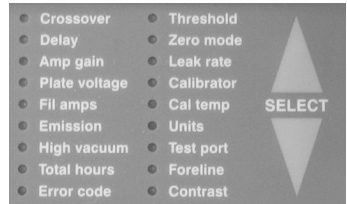
**D5/Minimum Gross Testing Time**

May be set from 1.0 to 999.9 seconds; the factory default is 1.0 second. Sets the minimum amount of time that the MS-60 will remain in the Gross test mode. Prevents unit from auto ranging and crossing over into Reverse flow mode before a gross leak is detected. Useful when testing large parts that may have a long helium response time.

D6/Minimum Rough Time

May be set from 1.0 to 999.9 seconds; the factory default is 1.0 second. Specifies minimum amount of time that MS-60 will remain in Roughing state before crossing over into a testing state. Useful for testing parts with high gas load which require extended pumping.

D7/Reverse Rough Close Delay

May be set from 1.0 to 999.9 seconds; the factory default is 1.0 second. If set to 999.9 seconds, external Rough valve will remain open for entire duration of Reverse flow testing. Keeps external Rough valve open for specified amount of time after reverse flow valve has opened. Only active on units equipped with external Rough valve option.

NOTE

In **Service** mode, the delay function displays:

D1 - the current software version stored in flash memory (e.g., FLASH 4.3).

D2 - the current software version stored in ROM (e.g., EPROM 1.5).

D3 - 10^{-7} range electrical offset; expressed as a fraction of a volt (e.g., 0.00xx).

D4 - 10^{-10} range electrical offset; expressed as a fraction of a volt (e.g., 0.00xx).

D5 - Indication is the same as in Standard mode, but no changes can be made.

D6 - Indication is the same as in Standard mode, but no changes can be made.

D7 - Indication is the same as in Standard mode, but no changes can be made.

AMP GAIN

Amplifier Gain. When this function is selected, the alphanumeric display indicates the setting of the leak rate amplifier (0.01 to 10.0).

Five different gains are used on the unit. The first, **G1**, is used for the unit's Gross flow mode, the second, **G2**, is used for the unit's Reverse flow mode and the third **G3**, is used for the unit's Direct flow mode. **G4** and **G5** are used for Sniff mode.

The five different gain settings can be displayed using the SELECT momentary switches when the AMP GAIN function has been selected (except **G1**, its value is only displayed when in the Service mode). Gain (calibration) of the MS-60 is changed in the Service mode by the SET momentary switches. Normally **G2** and **G3** are set automatically by the MS-60 during a Tune and Calibration cycle, however the **G2** and **G3** settings can be manually altered in Service mode. Note that **G1**, **G4** and **G5** are not controlled by the MS-60 and must be set by the user. **G1** may be set by the user when the MS-60 is leak testing in the Gross mode, or when the unit is in the Service mode. **G4** and **G5** can be set when the unit is in Sniff testing mode.

PLATE VOLTAGE

Plate Voltage Control. The alphanumeric display indicates the voltage supply to the plates. While the unit is in Standard mode, pressing either the left or right SET momentary switches adjusts the unit's peak tuning voltages either $\pm 30V$. This function, unique to VIC's MS series of leak detectors, is referred to as peak scan and is used to quickly verify if the mass spectrometer is properly tuned (refer to Section 2.8 for further information on the Peak Scan function). Releasing either momentary switch returns the anode voltage of the unit to its original value.

In Service Mode, the plate voltage may be altered incrementally by pressing either of the SET momentary switches. Note that the other peak voltages associated with the mass spectrometer follow the plate voltage setting; therefore the MS-60 can be manually tuned by changing the peak voltage.



CAUTION

Only qualified personnel should attempt to alter the anode voltage setting while the unit is in Service mode. As stated above, altering the peak tuning voltages will retune the mass spectrometer. Improper tuning will greatly effect the accuracy and reliability of the leak detector.

FIL AMPS

Filament Current. The alphanumeric display indicates the filament supply current, in D.C. Amps. The maximum current is 6.3 amps.

EMISSION

Emission Current. Indicates the filament emission current. The alphanumeric display will indicate the current in mA. A normally operating filament will have an emission current of 5mA, as regulated by the filament control circuit.

HIGH VACUUM

The alphanumeric display indicates pressure in the high-vacuum section (the area surrounding the filament within the spectrometer housing). If the unit's filament has been turned off, the display will state OFF, otherwise the display indicates the high vacuum pressure in either mtorr or mbar. If the leak rate units are set to std cc/sec the unit will display the pressure in mtorr. If the leak rate units are set to either mbar l/sec or Pa M3/sec the unit will display the pressure in mbar.

If the unit is in **Standby** mode, the alphanumeric display will occasionally display "MS-60". When this occurs, the unit is checking system offsets and not measuring Hi-Vac pressure.

TOTAL HRS

Total Hours. In Standard mode, the alphanumeric display indicates the total number of hours the unit has been in operation. In Service mode, the display indicates the time of day. The time (a 24 hour clock) can be altered by using the SET arrow keys (to change the hrs, min. and sec.) and the AUDIO arrow keys (to switch between the settings).

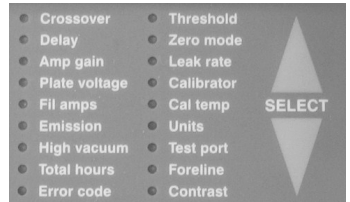
**ERROR CODE**

This function automatically appears after an error has occurred with the unit. When an error occurs, the alphanumeric display automatically switches to this function and displays the error code. The unit will display the code until the problem is resolved. This function is also selectable when using the SELECT momentary switches on the Service Panel. If in Standard mode, and this function is selected when a system error has not occurred, the word “NONE” will appear on the alphanumeric display.

In Service mode, selecting this function will display the current date. The date can be altered by using the SET arrow keys (to change the month, day, year) and the AUDIO arrow keys (to switch between the settings).

THRESHOLD

Two threshold settings are available and may be set in the Standard mode. In Service mode, this function is used to indicate the speed of the turbomolecular pump (the alphanumeric display indicates the percentage of the pumps rated speed).

THRESHOLD - RP

Reject Point. The alphanumeric display indicates the programmed leak rate value for the Reject/Accept indicator (the set point that indicates if the test object is below the maximum acceptable leak rate). This parameter may be altered only in Standard mode (password protected) by using the SET pushbuttons.

THRESHOLD - ZP

Zero Point. The alphanumeric display indicates the programmed leak rate value for when the unit will automatically zero below this setting in the Spray mode. This parameter may be altered only in Standard mode (password protected) by using the SET pushbuttons.

ZERO MODE

MS-60 offers five Zero modes, Normal, Spray, Hold, iZero and iHold (refer to section 2.8 for full operational details). The modes can be switch in either Standard (password protected) or Service modes using the SET pushbuttons.

LEAK RATE

The alphanumeric display indicates the actual current leak rate. Measurement is in either std cc/sec (standard cubic centimeters per second), mbar l/sec (millibar liter per second) or Pa M³/sec (Pascal meters cubed per second). Changes to the leak rate display can be made at the UNITS function.

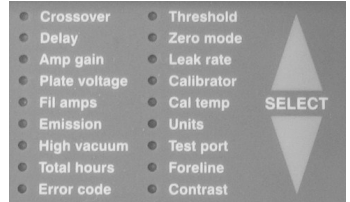
**CALIBRATOR - IN**

Internal Calibrator. In Standard mode, internal calibrated leak rate value is displayed. This parameter may be altered only in Service mode, by using the SET momentary switches. This parameter should only be changed when the internal calibrator has been replaced. Note that when the unit is in Standard mode, this function will display the current temperature-compensated value of the internal calibrator. This parameter may not be changed, since this value is derived from the leak rate value of the internal calibrator.

NOTE

To switch between the internal and external calibration settings, the unit is in the Standard mode and the password protection is enabled. The SET keys will switch between the internal and external settings. Only when you are in the Service mode can you make any changes to these settings.

CALIBRATOR - EX

External Calibrator. In Standard mode, external calibrated leak rate value is displayed. This parameter may be altered only in Service mode, by using the SET momentary switches.

CAL TEMP

Calibrator Temperature. When selected in Standard mode, the alphanumeric display will indicate the current temperature of the calibrator. When selected in Service mode, the alphanumeric display will indicate the temperature at which the internal helium reference standard was originally calibrated. This parameter may be altered in Service mode (using the SET pushbuttons), however; this setting should not be altered unless a new calibrator is installed in the unit.

UNITS

Allows change in the leak rate units. In either the Standard mode (with password protection unlocked) or the Service mode, the unit may be switched between STD cc/Sec, Mbar l/Sec or Pa M³/Sec, using the SET pushbuttons.

TEST PORT

Test Port Pressure. The alphanumeric display indicates the pressure of the test port. May be displayed in millitorr or millibar. The selection of units to be displayed is made by selecting the leak rate units (STD cc/Sec will display mtorr readings and Mbar l/Sec or Pa M³/Sec will display mbar readings throughout).

FORELINE

Foreline Pressure. The alphanumeric display indicates foreline pressure. May be displayed in millitorr or millibar. The selection of units to be displayed is made by selecting the leak rate units (STD cc/Sec will display mtorr readings and Mbar l/Sec or Pa M³/Sec will display mbar readings throughout).

CONTRAST

Allows adjustment (lighten to darken) of the alphanumeric display. In Standard mode, after the password protection is enabled, using the SET pushbuttons allows the display to change between 0 and 95. In the Service mode, the word UNLOCKED appears and by using the SET pushbuttons you can adjust the word lighter and darker.

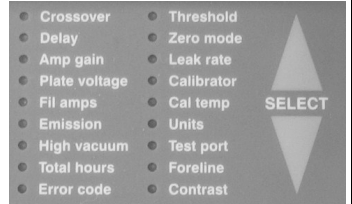

SELECT

Up/Down Arrow Keys. Momentary switches that allow the user to scroll through the functions located on the Service Panel. The LED next to each function indicates the function that has been selected. The selected function’s readout is displayed on the alphanumeric display.

ALPHANUMERIC DISPLAY

Ten character display. Used to indicate messages as well as the status of the selectable functions on the Service Panel. An LED next to the function indicates that the function has been selected, while this display indicates its current status or measurement. The display also indicates Error Message Codes (see Section 4.10 for a list of Error Codes).

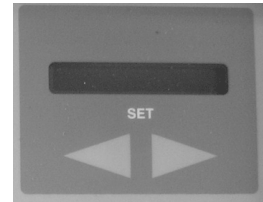

SET

Momentary arrow key switches that allow the user to increase or decrease the value of the settable functions.

FIL ON/OFF

Filament ON/OFF. Momentary switch. When the unit is in Service mode, pressing this switch will toggle the active filament on or off.

When the unit is in Standard mode, this switch also toggles the active filament on or off. However, whenever the unit is in Standard mode, the filament may be turned on only when the high-vacuum section has been sufficiently evacuated (as determined by the MS-60’s computer).



CAUTION

As described above, in Service mode, the spectrometer’s filament may be turned on or off at any time. In this mode, care should be taken to make sure that the high-vacuum section has been pumped down. If the filament is turned on when the high-vacuum section is at or near atmosphere, the filament will quickly burn out.

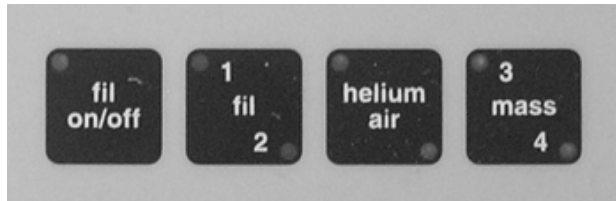

FIL 1/2

Filament 1 or 2 momentary switch. By pressing this switch, the user can toggle between Filament 1 and 2. A green indicator next to the 1 or 2 on this switch indicates that the respective filament is working properly.

HELIUM/AIR

Momentary Switch. Not selectable in Standard mode. By pressing this switch in Service mode, the user can toggle between air-equivalent and helium leak rate readings. The LED next to the HELIUM or AIR labels indicates which is active.

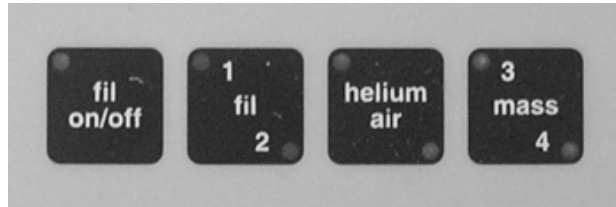
**MASS 3/4**

Momentary Switch. Not selectable in Standard mode. By pressing this switch in Service mode, the user can toggle between Mass 3 and Mass 4 helium tuning voltages. The LED next to the 3 or 4 indicates whether Mass 3 or Mass 4 is selected.

CAL CHECK

Calibration Check. Momentary Switch. Active only in Standard mode. Pressing this switch allows the user to initiate the unit's Calibration Check sequence in conjunction with the MS-60 internal calibrator. See Section 2.8 for a full description of the Calibration Check function.

CAL

Calibrate. Momentary Switch. Active only at the end of a Calibration Check sequence. Pressing this switch allows the user to initiate the unit's Auto Calibrating function (when using Mass 4 helium). Note that this function uses the unit's internal calibrator. The LED on the switch is lit while this sequence is in progress. See Section 2.8 for a full description of the Calibration function.

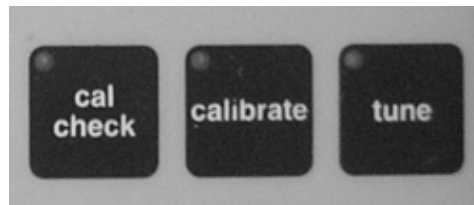
**TUNE**

Momentary Switch. Active only in Standard mode. Pressing this switch allows the user to initiate the unit's Auto Tune sequence in conjunction with the unit's internal calibrator. The MS-60 computer subsequently adjusts the detector's voltages for maximum sensitivity. The LED on the switch is lit while this sequence is in progress. See Section 2.8 for a full description of the Tune function.

The connectors that are listed below allow the MS-60 to interface with various external equipment. There are two groups of these panel connectors. The first group is the Electrical/Control that is located on the right side. The second group, located on the rear, is the Pneumatic.

DIGITAL INPUT

DIGITAL OUTPUTS

EXT. VALVES

This port allows the connection of the external roughing option to the MS-60. With the external roughing option, the unit's gross testing mode (10.0 to 1×10^{-4} std cc/sec) is automatically available. The connector has a sensing line that is engaged and then monitored by the MS-60 computer whenever the external rough valve is attached to the connector.

ANALOG

Allows monitoring of leak test as it progresses. Provides a 0-10V DC output corresponding to the leak rate mantissa of 0 to 10 (i.e., 2V represents 2.0×10^x).

RS-232

Allows a remote computer to operate the MS-60 in Standard mode and to record the leak rate/testing results of every leak rate measurement cycle. The port itself is a standard RS-232C connector.

HEADSET

A standard 1/8" connector. Allows the user to listen to audio tones. The audio tone indicates leak status - the higher the tone, the larger the leak. Most useful in noisy environments when the audio volume of the unit is not loud enough for an operator to clearly hear.

REMOTE (Optional)

Allows the handheld remote control to operate the MS-60. Most of the features of the user Control Panel are also on the remote control. Specifically, the remote control has an LED bar graph and numeric display indicating the measured leak rate of the test object, switches to select between Auto/Manual ranging, up/down arrow keys for use during manual ranging, auto zero button, a START button as well as a VENT button. The port itself is a standard telephone-type connector.

**ON/OFF**

Turns the MS-60 ON or OFF.

**A.C. CONNECTOR**

Allows A.C. power to be connected to the MS-60. A standard plug/cord is used.

SMIFF (Optional)

Sniffer Port. This port (a quick-connect fitting is attached to the port) is used to connect to VIC's external sniffer probe. When the sniffer probe is not connected to the unit, a plug (provided) should be installed in the connector whenever the unit is operating.

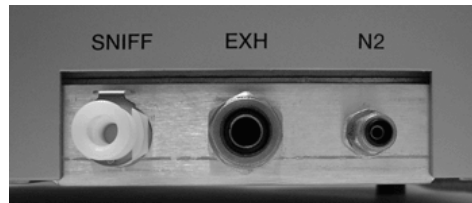
**EXH**

Internal Pump Exhaust. A standard 3/8" bulkhead connector allows the normal exhaust that the MS-60 produces during testing to be channeled directly to a user-provided exhaust system. Standard 3/8 inch tubing is used between the detector and the exhaust system.

N2

Nitrogen Purge Port. A standard 1/4" bulkhead connector. Allows the user to connect nitrogen to the purge fitting on the mechanical pump and to the vacuum system vent port.

2.3 STARTING THE MS-60 LEAK DETECTOR

Pre-Testing Start-Up Procedure

Ensure that all connections are secure and all utilities are available. Check that:

- A.C. power is connected.
- A helium supply source is ready and available (if applicable).
- There is a sufficient supply of oil in both the internal and external rough pumps if required.
- All external accessories are properly connected.

The MS-60 is started by pressing the ON/OFF power switch. During the Start-Up mode, the following will occur within the unit:

1. The unit will activate a self-diagnostic routine.
2. The foreline area will be pumped down.
3. The turbomolecular pump will spin up to its rated speed.
4. If the filament was on when the unit was last turned off, the filament will be on again at the end of the start-up mode. If the filament was off when the unit was turned off, the user will have to press the FIL ON momentary switch to turn on the filament.

When the Start-up mode has been completed, the Automatic Ranging indicator will be lit, the test port measurement gauge will be activated, the User Panel numeric display will indicate **3** and the READY light indicator will be lit.

2.4 LEAK TESTING

Leak testing is most often performed on the MS-60 by connecting a test object to the leak detector top test port.

Vacuum Testing

Through the use of the detector's internal rough pump (and external rough pump, if so equipped) the test object is evacuated. Once accomplished, the area of the test object suspected to have a leak is sprayed with helium gas. If there is a leak, the helium (and other gases) will pass through the leak in the test object:

1. The gases entering the unit are ionized (positively charged).
2. Helium molecules are separated from all other gas molecules.
3. Helium ions strike the collector plate causing an electron flow, which is amplified and displayed on the User/Service Panel.

An alternate and commonly used method is to test an object pre-filled with helium gas. The test object is placed in a test chamber (bell jar) that is evacuated and tested. The MS-60 subsequently displays the measurement of the leak from the product being tested on the User/Service Panel.

The procedure for leak testing an object in the MS-60 (without an external pump connected) is as follows:

1. Connect the test object to the test port located at the top of the MS-60 and press the green START pushbutton.
2. The reverse/foreline valve closes, the rough valve opens and the test object is evacuated.
3. When the test port pressure reaches Crossover **R** (7.5 Torr maximum), the reverse/foreline valve opens and Reverse flow testing begins.
4. If a vacuum testing procedure is underway, spraying of the test object with helium should now commence.
5. Leak testing begins in the 10^{-3} std cc/sec range.
6. The unit will continue to search for a leak, ranging downward until it reaches the 10^{-9} std cc/sec range.
7. If a leak is still not found, the unit will automatically begin Direct mode testing when the test port pressure goes below Crossover **D**. The rough valve will close, the direct (fine) valve will open and the leak detector will range downward to the 10^{-11} std cc/sec range.
8. If a leak is not found, the unit will continue to test at this level until the VENT pushbutton is pressed. If a leak is found, the unit will range upward to the proper range. The unit stays in Direct mode when ranging upward until it reaches the 10^{-4} range, where it crosses back into Reverse mode testing.
9. When leak testing has been completed, pressing and holding the VENT pushbutton (the default is for 0.5 second or may be programmed by the user - the D3 time interval) closes all vacuum system valves except for the foreline valve, opens the vent valve and vents the test port and test object.

The procedure for leak testing an object in the MS-60 with an external pump connected is as follows:

1. Connect the test object to the test port and press the green START pushbutton.
2. The external rough valve opens and the test object is evacuated.
3. As soon as roughing has commenced, the gross valve opens.
4. Gross leak testing mode begins in the 10^{-3} std cc/sec range.
5. If a vacuum testing procedure is underway, spraying of the test object with helium should now commence.
6. If a gross leak is detected the unit will range up to the appropriate decade, while the test object continues to be pumped down.
7. If no leak is found and the test port pressure has reached Crossover **R**, the unit will begin Reverse mode testing. The external rough valve and gross valve will close, the internal rough valve will open and the leak detector will range downward from the 10^{-3} std cc/sec range to the 10^{-9} std cc/sec range.
8. If again a leak is not found and the test port pressure has reached the Crossover **D** setting, the internal rough valve closes, the direct (fine) valve opens and the unit ranges to the 10^{-11} std cc/sec range in Direct mode testing.
9. The unit will continue to test at this level unless a leak is found or until the VENT pushbutton is pressed.
10. When leak testing has been completed, pressing and holding the VENT pushbutton (the default is for 0.5 second or may be programmed by the user - the D3 time interval) closes all vacuum system valves except for the foreline valve, opens the vent valve and vents the test port and test object.

Sniff Testing

Sniff Testing is performed by checking for escaping helium in a test object already filled with helium gas. Sniff testing is unique in that:

1. Leak detection is performed through a small orifice (a sniffer probe) that is attached to tubing that is then connected to the leak detector, and
2. the test object itself is not evacuated during testing.

By passing the sniffer probe over a suspected leak, out flowing helium from the test object is drawn into and measured by the system. This type of testing is most useful when testing large objects (e.g., large tanks) or when testing items that cannot withstand internal vacuum. Note that this type of testing is the least sensitive that the MS-60 can perform. A sniffer probe ultimately draws in some surrounding air that acts to dilute the helium leak tracer. Also note that sniffing is primarily a qualitative form of testing rather than a quantitative test; it is best used for locating leaks rather than measuring them.

The procedure for Sniff Testing is as follows:

1. Remove the plug that covers the sniffer port. Install the sniffer probe.
2. On the Service Panel press the SNIFF momentary switch. The Sniffer indicator light should now be lit.
3. The automatic ranging mode indicator is also lit. If the manual ranging mode is needed, press the Automatic/Manual Ranging button and set the expected leak rate range with the arrow keys. In either case, the unit will be able to test leaks within the 10^{-3} to 10^{-8} std cc/sec ranges.
4. Press the START pushbutton. The filament will be momentarily turned off while the sniffer is evacuated and the MS-60 crosses over into sniffing mode.
5. When the green Start light is illuminated, the unit is ready for testing. Using the probe, examine the test object for leaks.

High Sensitivity Sniff Testing (similar to the sniff testing procedure above except:)

1. The sniffer probe is connected to the top test port instead of a dedicated “sniff” port on the back of the machine.
2. Provides for greater sensitivity during testing.
3. Operates in Reverse flow mode rather than the Sniffing mode.

The procedure for High Sensitivity Sniff Testing is as follows:

1. Remove the KF25 blank that covers the test port. Install the sniffer assembly with the KF25 adapter.
2. Make sure that the MS-60 is in the Standard mode, not the Sniff mode.
3. Select either Automatic or Manual ranging. If Manual ranging is chosen set the MS-60 for the 10^{-9} range or higher; do not set it for the 10^{-10} range. In either case, the unit will be able to test leaks within the 10^{-3} to 10^{-9} std cc/sec ranges.
4. Press the START pushbutton. If the unit is set for Automatic ranging, it will range down to the level of the ambient helium. This background may be “zeroed out” for high sensitivity sniffing by pressing the “ZERO” pushbutton).
5. The unit is now ready for testing. Using the probe, examine the test object for leaks.

NOTE

The MS-60 will remain in the Reverse flow mode when sniffing through the test port. The pressure in the sniffer probe will prevent the unit from crossing over into the Direct flow mode.

2.5 SHUT DOWN PROCEDURE

The MS-60 may be shut down at any time by pressing the on/off (I/O) switch to the off (O) position. The unit automatically ensures that the vacuum system and system electronics are properly powered down. Turn off all peripheral equipment (i.e., external rough pump, printer, etc.).

2.6 SETTING TEST PARAMETERS

This section describes the testing parameters that may be modified by the user before and during actual leak testing. Usually, the factory default settings will be more than sufficient. However, specific tests may eventually require changes in these settings in order to optimally match any unique requirements of the test object.

The adjustable test parameters consist of various methods for the selection and timing of the opening and closing of the MS-60's vacuum system valves (as controlled by the system computer). The purpose of these timing adjustments and their settings are explained below. Please also refer to Chapter 3, **Theory of Operation** for further information.

Setting Crossover R

The MS-60 has two specific and important set points while leak testing. During testing, as the unit ranges downward, different testing modes and valve positions are required. Crossover **R** is defined as the set point where the unit switches from its "Gross Mode Testing" to "Reverse Mode Testing". All Gross Mode testing is performed in conjunction with the optional external pump. When using an external pump, the unit determines that the leak is smaller than a "gross" leak, the external roughing valve is closed and the unit's testing mode "crosses over" into **Reverse flow** testing. When the unit is used without an external pump, "cross over" is the point when roughing of the test object ends and Reverse mode testing begins.

To set the Crossover R parameter

1. Press the SELECT arrow keys until the green indicator next to Crossover and the alphanumeric display shows the pressure reading and **R**.
2. The Service Panel alphanumeric display will display a number up to 9,600 indicating the crossover set point in millitorr (mTorr) or millibar (depending upon which leak rate unit is selected). One mTorr is equal to 1×10^{-3} Torr and one millibar (mbar) is equal to 1×10^{-3} bar.
3. Unlock the unit using the password protection and press the left or right arrow keys to adjust the value ± 50 per depression.

Setting Crossover D

The second "crossover", Crossover **D**, is defined as the set point (the point during pump down) where the unit switches from Reverse mode testing to Direct mode testing. When the unit determines that the leak is smaller than a "reverse flow" leak, the fine valve opens, the internal rough valve closes and the unit "crosses over" into Direct flow testing.

To set the Crossover D parameter

1. Press the SELECT arrow keys until the green indicator next to Crossover and alphanumeric display shows the pressure reading and **D**.
2. The Service Panel alphanumeric display will display a number between 1 to 500 indicating the crossover set point in millitorr (mTorr) or millibar. One mTorr is equal to 1×10^{-3} Torr. One millibar (mbar) is equal to 1×10^{-3} bar.
3. Unlock the unit using the password protection and press the left or right arrow keys to adjust the value.

Setting the Accept/Reject Point (Threshold RP)

The Accept/Reject set point is the designated leak rate value that indicates whether or not the leak rate of the test object meets or fails a predefined maximum leak rate standard. For example, if the accept/reject set point has been set to 5×10^{-5} std cc/sec, any test object that has a leak rate of less than 5×10^{-5} std cc/sec would fall below the set point (into the accept area). Conversely, any test object that has a leak rate of 5×10^{-5} std cc/sec or greater falls into the predefined reject leak rate area.

To set the Accept/Reject set point

1. On the Service Panel, press either "Select" momentary switch until the green indicator next to the Threshold is lit and **RP** (reject point) is displayed on the alphanumeric display.
2. The alphanumeric display will display **RP** and the current Accept/Reject set point.
3. Unlock the unit using the password protection and press the left or right arrow keys to adjust value.

Delay Settings (Valve Timing Settings)

The MS-60 provides the user with the capability to set time intervals between the opening and closing of certain vacuum system valves. This allows the user to customize testing cycles to the unique requirements of any test object. In order to properly optimize testing procedures, we recommend that the MS-60 operator review the third chapter of this manual, **Theory of Operation**, prior to altering the default valve timing settings.

The Valve Timing Schematic displays the relationship between the opening and closing of the internal vacuum system valves. Also displayed in the schematic are the user-adjustable time delays of the rough, direct (fine) and vent valves and how they impact the test cycle.

The ways in which delay settings may be used to benefit certain testing conditions are described below:

D1/Fine Crossover Delay - Occurs after Crossover **D** has been reached and refers to the delay (in seconds) between the attainment of Crossover **D** and the onset of Direct testing (the opening of the direct (fine) valve). With D1 at the factory default setting, the Fine valve will open 1.0 second after the Crossover **D** set point has been reached. The MS-60 remains in Reverse flow testing for the duration of D1.

Note that if the MS-60 is set for Manual ranging on the 10^{-10} range, the unit will remain in the roughing state after reaching Crossover **D** for the duration of D1.

D2/Direct Rough Valve Close Delay - Occurs when Crossover **D** has been reached; represents the amount of time (in seconds) that the Rough valve remains open after the direct (fine) valve opens (the rough valve needs to be closed so that Direct Testing may occur). With D2 at the factory default setting, the rough valve closes 0.1 second after the direct valve opens (i.e., after Crossover **D** set point has been reached). D2 may be set from 1.0 to 999.9 seconds. If the test object has a large volume, or the test material produces a larger than normal amount of out gassing, it will be helpful to increase this delay limit in order to limit the pressure burst that occurs during crossover.

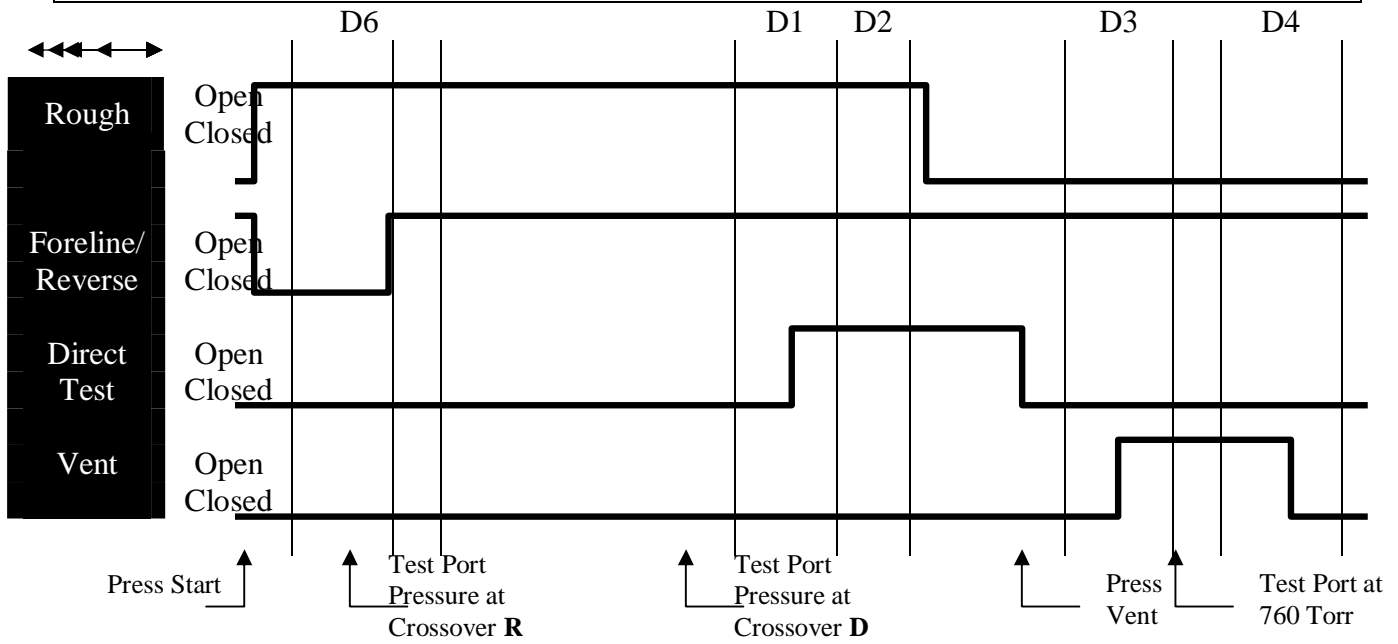

MS-60 Standard - Valve Timing Schematic

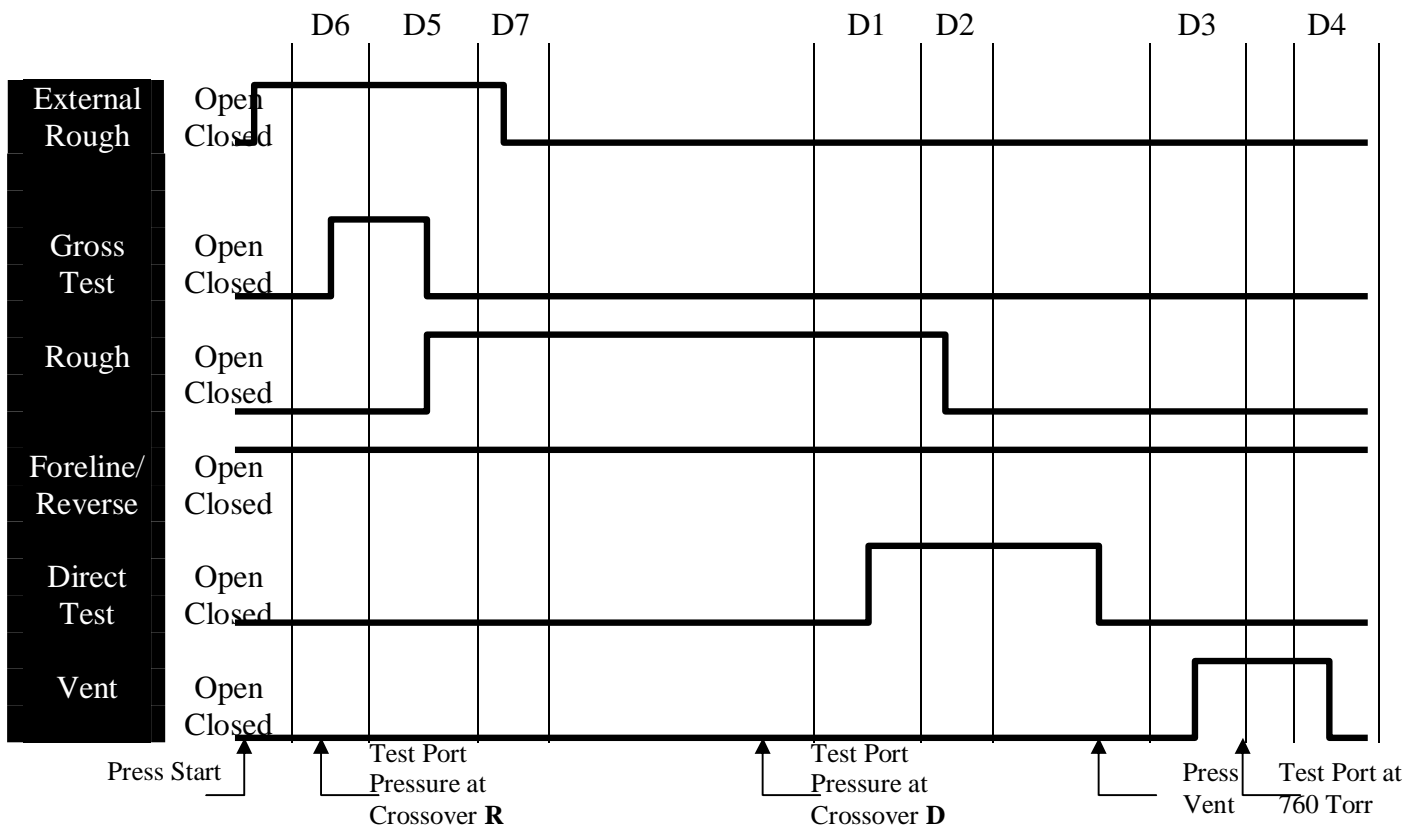

MS-60 with External Rough Pump Option - Valve Timing Schematic

D1: Direct Crossover Delay D3: Vent Open Delay D5: Minimum Gross Time D7: Reverse Rough Close Delay
 D2: Direct Rough Close Delay D4: Vent Duration D6: Minimum Rough Time

D3/Vent Delay - The Vent Delay is the period of time (in seconds) that the MS-60 operator must hold down the "VENT" pushbutton before venting of the test object will occur. The delay is useful to prevent accidental venting of the system. The factory default for D3 is 1.0 second. This time is usually sufficient to prevent accidental activation of the vent cycle. The vent delay may be programmed from 1.0 to 999.9 seconds.

D4/Vent Duration - Vent Duration refers to the amount of time (in seconds) that the Vent valve will remain open. D4 is adjustable between 3.0 to 999.9 seconds (the factory default setting is 3.0 second) allowing the operator to optimize the venting of a particular test object.

D5/Minimum Gross Testing Time - Sets the minimum amount of time that the MS-60 will remain in the Gross test mode. Operator adjusts D5 to prevent unit from auto ranging and crossing over into Reverse flow mode before a gross leak is detected. Useful when testing large parts that may have long helium response time. D5 can be set from 1.0 to 999.9 seconds (the factory default setting is 1.0 second).

D6/Minimum Rough Time - Specifies minimum amount of time that MS-60 will remain in Roughing state before crossing over into a testing state. Useful for testing parts with high gas load which require extended pumping. D6 can be set from 1.0 to 999.9 seconds (the factory default setting is 1.0 second).

D7/Reverse Rough Close Delay - Keeps external rough valve open for specified amount of time after reverse flow valve has opened. D7 can be set from 1.0 to 999.9 seconds (if set to 999.9 seconds, external rough valve will remain open for entire duration of Reverse Flow testing). The factory default setting for D7 is 1.0 second. D7 is active only on units equipped with the external rough option.

Changing Delay Settings (D1-D7)

All delay settings may be altered by the operator via the MS-60 User Panel using the same basic procedure, as follows:

1. On the User Panel, press either SELECT momentary switch until the green indicator next to the word Delay lights.
2. The alphanumeric display will show the first delay parameter, **D1** and the currently selected delay interval for D1 (for example, a display of D1 2.0 S indicates that the direct (fine) Crossover Delay is set to 2.0 seconds).
3. Unlock the unit using the password protection and the delay interval can now be increased or decreased by pressing the SET keys until the desired setting appears.
4. To display **D2** through **D7**, continue pressing the same SELECT momentary switch; the indicator light will not move to the next function until all seven delay parameters have been cycled. When the desired delay parameter appears in the alphanumeric display, it can be adjusted as in **Step 3**.

2.7 SETTING ADDITIONAL PARAMETERS

AMPLIFIER GAIN

When this function is selected, the alphanumeric display indicates the gain setting of the leak rate amplifier (from 0.1 to 10.0). The amplifier gain is the multiplier used by the computer to compensate for changes in sensitivity of the mass spectrometer. The user will only use this function when calibrating using a known external leak source or when unable to otherwise properly calibrate the unit.

Five separate gains are available:

- G1** refers to the gain while the unit is in **Gross flow** mode
- G2** refers to the gain while the unit is in **Reverse flow** mode
- G3** refers to the gain while the unit is in **Direct flow** mode
- G4** refers to the gain while the unit is in **Sniff** mode
- G5** refers to the gain while the unit is in **power sniff** mode.

To alter the Amplifier Gain settings:

1. Place the unit in the Service mode and press either SELECT key on the User Panel until the indicator light beside AMP GAIN is illuminated. Continuing to press the same SELECT key will display each gain parameter (G1–G5) in sequence before the indicator moves to the next function.
2. When the desired gain parameter is displayed, press either the left or right SET key to decrease or increase the Amplifier Gain.

NOTE

G1 (Gross mode gain) may be set in the Standard mode when the MS-60 is leak testing in Gross and Sniff mode range.

G2 and **G3** are automatically set by the unit's computer during tune or calibration so it may properly calibrate the unit. When in Service mode, if the operator changes the gain, the calibration will no longer be correct. However, **G4** and **G5** are always set by the user.

PLATE VOLTAGE

Displays the plate voltage of the mass spectrometer source. When this function is selected while the unit is in Standard mode, the Peak Scan function will be activated (see section 2.8). When the unit is in Service mode, pressing either of the SET switches alters the unit's peak voltages and allows the user to manually tune the mass spectrometer.

HELIUM/AIR MEASUREMENTS

This toggle switch allows the user to select either air-equivalent or helium leak rate readings. This function is only available in Service mode.

MASS 3/4 HELIUM

This toggle switch allows the MS-60 to switch between Mass 3 and Mass 4 tuning voltages. This function is only available in Service Mode.

2.8 TEST AIDS & PROCEDURES

AZ³ AUTO ZERO

NORMAL ZERO MODE

The “Auto-Zero” or “Zero” feature, activated from the User Panel, allows the operator to test with the presence of residual helium. Pressing the ZERO button will cancel out the measurement of any helium present in the vacuum system or test object (the unit will display the amount of helium above the “zeroed out” amount).

The Zero function works in all test modes (Gross, Reverse and Direct, and also when using the Sniffer probe). When activated helium present and being measured in the vacuum system is “zeroed” out on the leak test bar graph and therefore is not counted as part of the test.

When the Zero function has been activated, leak test measurement is automatically restricted to two ranges below the current range. When auto-ranging, the unit will automatically stop two decades below the point when the Zero button was pressed. When manually ranging, the unit will emit a short beep whenever the user attempts to range more than one decade below the point when the Zero button was pressed.

Note that when the Zero function is activated, it does not inhibit ranging upward during testing. The Zero function is canceled at the end of a test cycle (i.e., when the VENT button is pushed); it can also be canceled by halting the test cycle (pushing the START button a second time).

iZERO MODE

iZERO is intended for measuring leak rates in the 10 or 11 range. When measuring larger leak rates, very little benefit will be realized for the reduction in throughput. There are two primary differences between the NORMAL ZERO and iZERO modes.

1. iZERO will force the user to wait about 20 seconds after a test cycle before the next test cycle can be started. The ZERO LED will blink during this time. After the wait period, the next test is allowed to start. During this time the MS-60 is allowing the background to stabilize before sampling it. Note: In the NORMAL ZERO mode, the ZERO led will blink suggesting the user to wait before starting the next cycle but the MS-60 will not enforce the delayed start and the user can start the next test cycle at any time.
2. After pressing the ZERO button, the MS60 will attempt to pump down into the 10 range, then the MS60 will start to analyze the slope of the voltage from the collector. When the collector voltage changes less than 100uV\Second the MS60 will capture the ZERO value at that point in time. The ZERO led will blink while the MS60 is analyzing the collector voltage slope.

SPRAY ZERO

Spray zero is intended to be used during spray type leak detection. This leak test method requires an operator to spray Helium on the outside of an evacuated part connected to the MS60 test port. The test cycle follows a normal sequence but adds an automatic zero assertion. The zero assertion is based on the comparison of the leak rate signal to a predefined zero threshold.

Activation of Spray Zero is as follows:

1. Select Zero mode and unlock the unit using the password protection.
2. Select SPRAY from the menu.
3. Select Threshold **ZP** and set the zero threshold.

The following functions are automatically performed by the machine during operation:

1. Following crossover into test mode, delay for 1 second before monitoring of the leak rate begins. Only delay monitoring; all other operation including leak rate display behave as normal.
2. After the 1 second delay, the unit compares the leak rate to the zero threshold value.
3. When this condition is met; (leak rate < zero threshold) the unit activates auto zero just as if an operator pressed the zero button.
4. The zero trigger is only applied once and is reset during the next leak test cycle.
5. All other zero functions continue to operate including negative background correction and manual zero assertion.

The following is an example of Zero Threshold set at $5.5E-9$

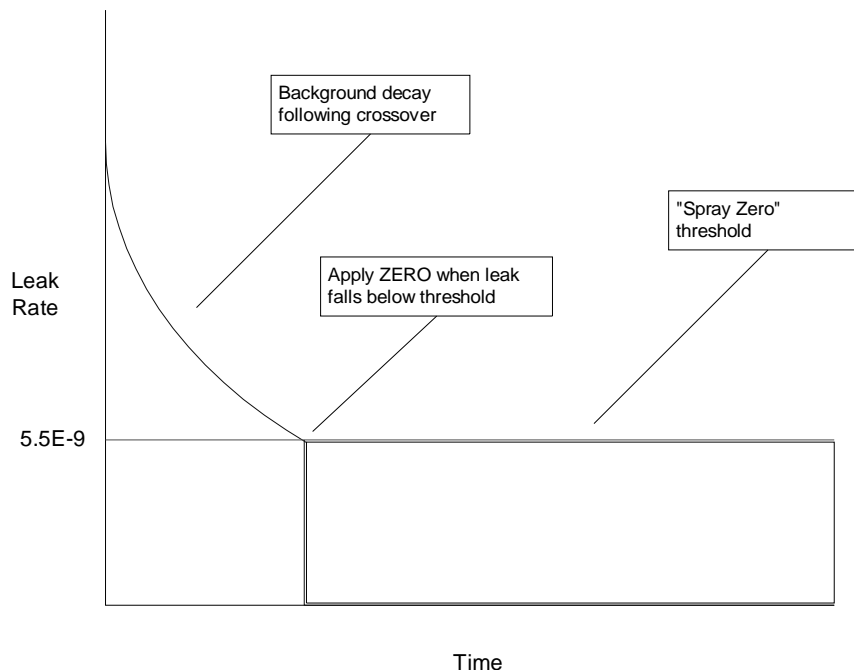

HOLD MODE

Hold mode zero is used when an external testing chamber is attached to the test port. Often an external test chamber introduces a fixed positive leak rate due to chamber leakage and o-ring permeation. This offset adds to the leak rate reading obtained from leaking parts placed in the chamber. The chamber "background" is subtracted from the total to derive at the actual part leakage.

Hold mode zero allows an operator to apply a fixed zero correction, which compensates for the chamber background. The process is as follows:

1. After unlocking the machine using the password protection, the HOLD zero is selected from the Zero mode.
2. An operator tests an empty chamber (no parts).
3. Following crossover and after allowing the background to stabilize, the operator presses ZERO. The background for the empty chamber is applied and held.
4. The operator presses VENT and unlike the normal zero mode, the zero is not reset but held for the next test.
5. Testing continues with the chamber background nulled.
6. If the operator again decides to acquire a zero the zero button is pressed again. As with before the zero value is held over from test to test.
7. The zero is reset when either Spray or Normal mode is selected.
8. Negative background correction operates as normal both in and out of test mode.

iHOLD MODE

iHOLD is intended for measuring leak rates in the 10 or 11 range. When measuring larger leak rates, very little benefit will be realized for the reduction in throughput. There are two primary differences between the HOLD MODE and iHOLD modes.

3. iHOLD will force the user to wait about 20 seconds after a test cycle before the next test cycle can be started. The ZERO LED will blink during this time. After the wait period, the next test is allowed to start. During this time the MS-60 is allowing the background to stabilize before sampling it.
 4. After pressing the ZERO button, the MS60 will attempt to pump down into the 10 range, then the MS60 will start to analyze the slope of the voltage from the collector. When the collector voltage changes less than 100uV\Second the MS60 will capture the ZERO value at that point in time. The ZERO led will blink while the MS60 is analyzing the collector voltage slope.
- The operator presses VENT and unlike normal zero mode, the zero is not reset but held for the next test.
 - Testing continues with the chamber background nulled.
 - If the operator again decides to acquire a zero he presses the zero button. As with before the zero value is held over from test to test.
 - The iHold is reset when either Spray or Normal mode is selected.

PEAK SCAN

Peak Scan is a function the operator can use to quickly verify that the unit is operating correctly. By using this function while in Standard mode, the user can ascertain whether the leak rate indication is due to helium or is the result of a poorly tuned spectrometer.

By changing the function on the Service Panel to Plate Voltage while still in Standard mode, and by then pressing either the left or right SET buttons, the user will temporarily alter the spectrometer peak tuning voltages either -30 or +30 volts from its prior setting (releasing either button will return the voltages to its normal condition). If this is done to an optimally tuned spectrometer, the displayed leak rate will decrease to zero indicating that the measurement is actually due to the presence of helium. Both SET buttons should be used for this test. If the displayed leak rate does not decrease to zero after either SET button is pressed, the spectrometer is not tuned and the TUNE function must be initiated to retune the mass spectrometer.

CALIBRATION CHECK (CAL CHECK)

Cal Check is the feature that allows the user to verify the measurement accuracy of the MS-60 leak detector. The unit automatically connects the internal leak rate standard of the unit to the test port, measures the internal calibrator value, subtracts the background helium measurement and displays the results on the Leak Rate Bar Graph located on the User Panel. The Cal Check function is activated by pressing the CAL CHECK momentary switch on the Service Panel.

When the indicator on the Cal Check momentary switch begins flashing, the MS-60 has completed its measurement cycle and the Cal Check reading from the User Panel should now be compared to the display on the Service Panel (when Leak Rate indication is selected). The alphanumeric display of the Service Panel indicates the calculated temperature compensated value of the internal leak rate standard. The leak rate bar graph indicates the measured value of the internal calibrator.

The unit is considered to be measuring accurately whenever the two readings are within 10% of each other. If the difference between the two readings is greater than 10%, the measurement gain may be adjusted by pressing the CAL (Calibrate) button or the leak detector may be re-tuned and re-calibrated by pressing the TUNE button. If the two readings are within 10%, pressing the Cal Check momentary switch ends the Cal Check cycle.

NOTE

During the warm-up period of the unit (approximately one-half hour), the leak detector's calibration will not be as accurate as during normal operation. When using the MS-60 during warm-up, perform the Cal Check function to ensure the integrity of the unit's measurement accuracy.

CALIBRATE

Pressing the Calibrate momentary switch activates the Calibration function.

The Calibration function of the leak detector is available only after the Cal Check procedure has been completed. After the Cal Check cycle is completed, when the actual leak rate measured by the unit is close to, but not exactly the same as the internal leak rate standard, the Calibration function may be used. Since the Calibration function adjusts the amplifier gain, once initiated, the leak value of the Cal Check function will now conform to the internal leak rate standard. Note that consistent differences greater than 15% may indicate an improperly tuned mass spectrometer or a fault within the unit.

TUNE

Pressing the TUNE momentary switch initiates an automatic tuning cycle. During the tuning cycle, voltages applied to the mass spectrometer are adjusted and optimized for peak sensitivity and performance. It is recommended that the Tune function be used in conjunction with the Cal Check function. Since the Calibration function basically increases or decreases the measurement gain of the unit, without the optimization of the Tune function, the unit eventually may not be able to self-calibrate.

Theory Of Operation

3.1 INTRODUCTION TO LEAK DETECTION THEORY

When designing and manufacturing systems that contain gases or fluids, or systems that are normally evacuated, the manufacturer or tester must take into account the degree of leakage that can occur. To qualify these products, various methods may be selected to test these products for leaks. The amount of actual leakage that can be tolerated is different for every application and therefore must be determined from the conditions of the application itself. From this data the manufacturer will be able to establish the limits of maximum permissible leakage and will also be able to determine the maximum permissible pressure levels within a product or system under actual working conditions. Also, the manufacturer might need the ability to discover and localize any leaks in the product or system tested. In all cases, the maximum allowable leak rate, as well as the testing methods and procedures, should be specified before a product or system is manufactured.

Many commercial, industrial and military products and processes require hermetic sealing. In general, these products include equipment exposed to pressures above or below those of its immediate environment, such as: vacuum equipment used in the manufacture of semiconductors and related research; and items produced for industrial and commercial applications, most notably the refrigeration and automotive industries. Hermetic tightness (sealing) is narrowly defined as the absence of leakage, however, no manufactured object can be considered totally leak tight. Statements such as “no detectable leaks” or “zero leakage” are not valid specifications for acceptance testing. Even in the absence of a defect within a product or system, gas will always permeate through metal, crystals, polymers and glasses. Therefore, “leak tightness” is only a relative term.

The degree of permissible leakage depends on how and where the product or system is to be used, the amount of the object’s content (liquid or gas) that is permitted to escape over a certain time period, or the amount of external atmosphere or liquid that is permitted to penetrate the object over a certain time period. The size of the permissible leak is defined as part of the performance requirements of the product or system. Leak standards are set for the following reasons:

- To prevent the loss of contained gases or liquids.
- To prevent hazards caused by escaping toxic materials.
- To prevent contamination due to materials leaking from or leaking into an object.
- To test the projected reliability of sealed systems or the components within the systems.

When setting the limits of allowable leakage, it is always necessary to set a practical leakage level for the product under testing. Decreasing the permissible leak rate below a practical level and increasing the sensitivity of the required test method can increase the test cycle time, the cost of performing a test, and the cost of a product.

Leak testing is divided into two general categories, Leak Measurement and Leak Location.

Leak Measurement is the quantified assessment of an object’s or system's leak rate and is also the preferred method of determining that a leak does exist. **Leak Location** is the procedure of

pinpointing the precise location of individual leaks. When testing an object, the most reliable sequence is to first measure the total leakage of a test object, and then, if necessary, determine the location of individual leaks.

A leak rate specification should take into account the effect of leakage on the system and its application. Long-term storage of the object or system may be necessary and should be considered when creating a leakage standard.

Any leak detection procedure requires careful planning. Ample consideration to test sensitivity and response time is required when testing any object. At times, it may be preferable to specify a maximum tolerable leakage rather than specifying a maximum allowable leak rate. The maximum tolerable leak rate value may be calculated by multiplying the maximum allowable leak rate by the length of time a system or object is expected to be used (including storage time). If a gas or liquid is not introduced to the system or object until it becomes operational (at some future date), the maximum tolerable leakage need only be specified for the duration of its operation. The level of the maximum tolerable leakage should always be specified when the total amount of leakage is more important than the leak rate.

A commonly used method for determining the maximum allowable leak rate is derived from the consideration of leaks in the following situations:

- System failure during the operational life of the system.
- Hazards to personnel and equipment when leaks occur.
- Unacceptable appearance of the system.
- Assurance of proper design and construction of the manufactured equipment.

When considering these four factors and determining system specifications, the smallest leak rate will be the maximum allowable leak rate. If the content of the test object is liquid, it is necessary to correlate the maximum liquid leak rate to the leak rate of helium. Once the maximum leak rate of the liquid in the test object has been calculated, it is very simple to conduct an accurate leak test for an object designed to contain liquid, since a calibrated helium gas standard is an integral part of the MS-60.

Of all the instruments and devices used for leak detection, helium-sensitive mass spectrometer based leak detectors such as the MS-60 have been proven to be by far the most sensitive and accurate. Further, this type of unit is generally easily calibrated, does not require operator judgement to be used effectively, and most importantly, is not destructive or harmful to test personnel or the tested object.

...

The remainder of this chapter describes in detail the operation of the MS-60 portable leak detector. It is divided into a discussion of Direct and Reverse flow modes, a functional description of the leak detector and a description of the major components and their functions within the MS-60.

3.2 DIRECT FLOW & REVERSE FLOW MODES

The MS-60 is capable of detecting leaks in three separate modes: Gross mode, Reverse flow mode and Direct flow mode. All three modes are controlled directly and automatically by the MS-60's computer.

REVERSE FLOW

The Reverse flow mode is particularly useful for detecting and measuring leaks in test objects that have a high degree of out-gassing or when a fast crossover at a high test port pressure is desired. In this mode, testing for "Gross" leaks is accomplished by connecting an external roughing pump to the vacuum system, opening the external rough valve, the foreline valve and the gross valve. All other valves are closed. The test port is connected to the foreline of the turbomolecular pump through a restriction. This allows the sample helium to back diffuse through the pump. When testing in Reverse mode, the foreline pressure is usually in the 10^{-3} Torr range or greater, the turbomolecular pump actually acts as a buffer against pressure bursts into the high vacuum section (the area containing the mass spectrometer). Therefore, crossover can occur at much higher pressures in Reverse flow mode than in Direct flow mode. For the MS-60, the Gross mode leak measurement range is as 10 to 1×10^{-3} std cc/sec.

Without an external pump, Gross mode is not available. If the unit is unable to pump down the test object to a sufficient level to begin testing in Reverse flow mode, actual leak testing will not begin. The unit will remain in its roughing state until the operator stops the test cycle. Since the maximum crossover for the MS-60 is quite high, this may be an indication that the test object has a very large leak.

When the test port pressure reaches the pre-designated "crossover **R**" set point (7.5 Torr maximum), the unit will "crossover" into reverse flow mode testing (the actual point of crossover may be set by the system operator). At crossover, the foreline valve opens, the internal rough valve remains open, while all other valves are closed. Gases from the test object are introduced into the foreline of the turbomolecular pump, and "back-diffuse" through the pump. As in Gross mode testing, the turbomolecular pump acts as a buffer against pressure bursts into the high vacuum section (the area containing the mass spectrometer). For the MS-60, the Reverse flow mode leak measurement range is 10×10^{-3} to 5×10^{-11} std cc/sec.

DIRECT FLOW

The Direct flow mode is ideal for testing parts that have a leak rate specification less than 5×10^{-10} std cc/sec, or when testing objects that are clean, dry and cannot tolerate exposure to back streaming mechanical pump oil vapors during testing. In this mode, the test object is directly connected to the high vacuum section and therefore the mass spectrometer. This allows for much higher sensitivity and ultra-clean testing in comparison with Reverse flow mode, but requires a much lower crossover pressure.

During Direct flow mode testing, the direct (fine) valve and foreline valves are open. All other valves are closed. Crossover takes place when the test port is at 100 millitorr or less (adjustable by the system operator). The Direct mode test leak range is from 10×10^{-6} to 5×10^{-12} std cc/sec. Note that once the MS-60 has crossed over into its Direct flow mode, and needs to range upward, it will stay in this mode until it reaches the top of the 10^{-6} range.

3.3 FUNCTIONAL DESCRIPTION OF OPERATION

The MS-60 is a portable, helium mass spectrometer leak detector that may be used for both quantifying and locating leaks in objects that can be evacuated or pressurized. Helium that is present in a test object is drawn into the unit (either through the test port or through the sniffer valve), isolated and detected by a mass spectrometer, and converted into an electric signal. The electric signal generated is proportional to the leak rate of the helium drawn through the leak found in the test object. Once this signal is amplified, the signal is displayed as a leak rate on the User Panel of the MS-60.

Helium is used as a tracer gas because of its unique combination of properties:

- Helium is present in the atmosphere at a rate of only 5 parts per million (ppm); therefore it is unusual to find a high atmospheric background of helium that may disrupt testing.
- Helium is neither explosive nor toxic; it is completely inert and will not contaminate a test object.
- Helium does not contaminate nor desensitize its own detector as is common with detectors using other tracer gases.
- Helium molecules are small (mass 3 or 4 helium may be used for the MS-60) and therefore flow readily through extremely small leaks.

The operation of the MS-60 is discussed below. The operator of the unit should use this information in conjunction with the unit's Vacuum Schematic Diagram. The description follows the sequence of a basic test cycle. A test cycle is started by connecting a test object to the test port (or by connecting the sniffer probe to the sniffer port) and by pressing the START button.

Prior to testing, ensure that the unit is in its functional READY state. The START-UP procedure is described in Section 2.3. When the unit is ready for testing, the vacuum system will have the following status:

1. The internal mechanical pump and the turbomolecular pump will be functioning; the external mechanical pump will also be functioning (if installed).
2. The foreline valve will be open; all other valves will be closed.
3. The "Hi-Vac" system will be fully evacuated by the turbomolecular pump.

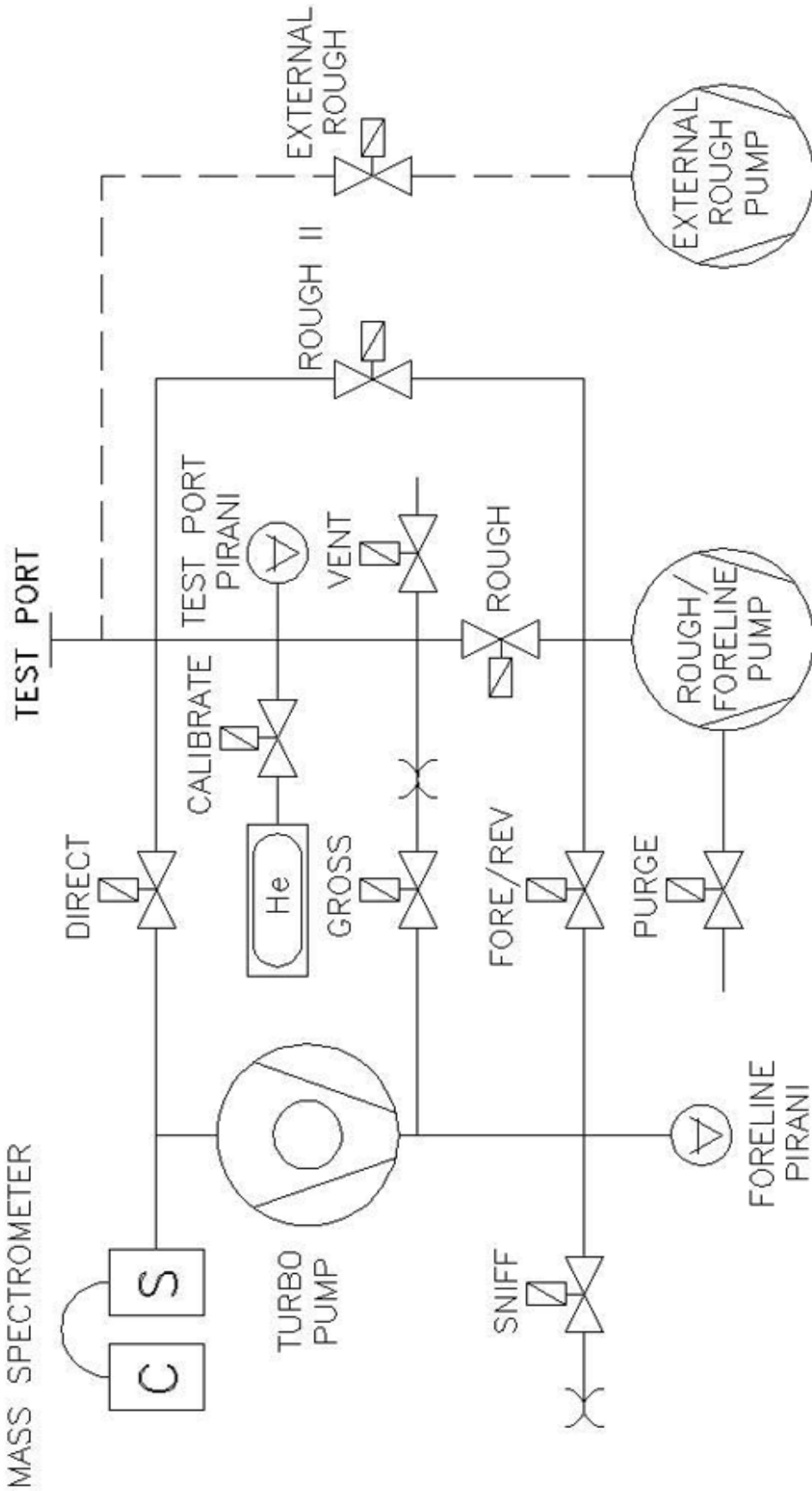

MS-60 Vacuum System Schematic Diagram

Pressing the START pushbutton opens the rough valve. The internal rotary vane mechanical pump (the roughing pump) or the external roughing pump (when equipped with the unit) will begin to evacuate the test object. A Pirani gauge connected to the test port monitors the pressure within the test port and test object.

In systems without an external roughing pump, the internal mechanical pump serves as both the roughing and foreline pump. Consequently, during the roughing state, the foreline valve is closed. Note that due to the advanced design of the MS-60 system, the turbomolecular pump has an extremely high foreline tolerance. This allows for much longer than normal roughing intervals.

The MS-60's computer monitors foreline pressure using its foreline Pirani gauge. If foreline pressure reaches 1,000 millitorr, the MS-60 computer will stop the roughing cycle by closing the internal roughing valve and opening the foreline valve. When foreline pressure has been brought back down to 150 millitorr, the roughing cycle is resumed.

Testing begins once the pressure at the test port reaches the pre-set crossover set point for the appropriate test mode.

The sample gases of the test object disperse throughout the confines of the Hi-Vac section. As gas molecules enter the ion source chamber of the mass spectrometer, an electrically heated filament provides a source of electrons that collide with the gas molecules and produce positively charged ions. The production of these ions is referred to as ionization. Due to the differences in mass of the ionized gases, only helium ions have the ability to traverse the two 90° magnetic sections of the spectrometer housing to the collector. It is at the collector that the ions are converted into an electrical current and then processed by the MS-60 computer for display on the User Panel. The MS-60 has been programmed with the ability to test using either Mass 3 or Mass 4 helium.

When the unit is equipped with an external mechanical pump, the unit will "cross over" into Reverse flow mode testing only after Gross mode testing is complete (assuming a leak has not been detected). In the vacuum system the internal rough valve is opened and the foreline valve remains open, all other valves are closed. During crossover, the equalization of pressures may cause a temporary increase in foreline pressure (this increase is termed a **burst**). If a burst should cause the foreline pressure to increase to over 7,000 millitorr, the test cycle will be aborted and ERROR 05 will be posted. If a burst should cause the foreline pressure to increase to over 8,000 millitorr, the filament will be turned off, all valves except the foreline will be closed, the turbo pump will be turned off, and ERROR 01 will be posted. See Error Codes in section 4.10 for further information. The crossover pressure (Crossover **R**) should be adjusted by the User to provide the shortest possible test cycle duration without producing excessive pressure bursts into the foreline region of the unit. Note that since foreline tolerance is very high, the usual result of the increase of foreline pressure will be a variable background reading.

If no measurable leaks are found in Reverse flow mode, Direct flow testing begins. Within the vacuum system, the direct (fine) valve is opened while the rough valve closes. At this point the test port is fully connected to the high-vacuum section. The equalization of the two pressures will cause a pressure burst in the high-vacuum section. If the burst is over 5×10^{-4} Torr, the mass spectrometer filament will be turned off for 10 seconds and ERROR 02 will be posted. The system will then turn the filament back on and attempt to resume testing (see Error Codes, section 4.10, for further information).

To prevent an excessive pressure burst, the test port may be evacuated for a longer period by lowering the crossover pressure (Crossover **D** - refer to Section 2.6 for information on how to adjust this parameter) or by changing the “delay” setting (refer to Section 2.6 for detailed information on delay parameters). In this case, delay refers to either delaying the opening of the direct (fine) valve (the direct connection between the high-vacuum section and the test port) or the closing of the rough valve (allowing further evacuation of the test port/test object volume). Optimizing these two parameters allows the user to shorten the test cycle while still being able to safely operate the unit.

Often the setting of delays will depend on the size of the test object. Smaller, cleaner objects will tend to produce small pressure bursts and therefore use relatively high crossover set points. Larger, dirtier objects tend to produce larger bursts that can be prevented by extending the roughing time to delay the onset of Direct flow mode testing.

After Crossover **D** has been reached, and the unit is in the Direct testing mode, pressure in the test object continues to be reduced until it is equalized with the high-vacuum section. Concurrently, the MS-60 ranges downward to the ultimate direct flow sensitivity of 5×10^{-12} std cc/sec, unless a larger leak is found.

The test is terminated by pressing either the VENT or START pushbuttons. The unit's computer will then close either the direct (fine), rough or gross valve (dependent on the current testing mode). Note that once the START pushbutton is pressed, the unit is placed in its STANDBY mode (without any venting the test port). If the VENT button is depressed for a period of time (as adjusted by the User, see Section 2.6 for instructions on setting this “delay”) the unit will open the vent valve. The opening of the vent valve brings the test object back to atmospheric pressure, thereby allowing it to be removed from the leak detector's test port. The duration of venting is also adjustable (again see Section 2.6 for instructions on setting the delay of the venting period). If the ambient air in the testing area has a high moisture content, it is advisable to vent the unit with dry nitrogen. Using dry nitrogen prevents water vapor from collecting in the unit, which then must be pumped out during the next testing cycle.

The MS-60 is automatically tuned and calibrated by using the factory-installed temperature compensated helium standard, (which is traceable to National Institute of Standards Technology) as a reference. During tuning, the unit's computer controls the vacuum system's valves and adjusts the various voltages of the mass spectrometer to obtain an optimum response to the helium signal from the reference standard. After the voltages are optimized, the gain of the amplifier is adjusted until the displayed leak rate value corresponds to the temperature compensated value of the helium standard.

In the Sniff test mode, the sniffer port has a direct internal connection to the test port. The flow rate of the sniffed gases is limited by the size of the fixed leak in the sniffer probe.

In the event of a power failure, all valves within the vacuum system will automatically close. The mechanical pump will shut off, the turbomolecular pump will also shut off, however, and it will take several minutes for the blades of the turbomolecular pump to stop spinning. When power is again available, the unit will automatically begin its normal “power-up” sequence. If, before the power failure, the filament was activated, the unit will power-up with the filament on. If the filament was off prior to power loss, the User will have to manually activate the filament (by pressing the FIL ON momentary switch located on the User Panel).

3.4 DESCRIPTION OF MAJOR COMPONENTS

VACUUM SYSTEM

MASS SPECTROMETER

The mass spectrometer is the component of the vacuum system that detects the helium tracer gas present in the test object. The unit ionizes the gas molecules, separates the helium ions from other gas ions, and converts the helium ions into an electrical current that represents the size of the leak. The spectrometer consists of three parts:

- the ion source assembly
- the mass spectrometer magnets, and
- the ion collector

ION SOURCE ASSEMBLY

To permit neutral atoms and molecules of gas to be separated by a magnetic mass spectrometer, they must first be ionized in the Ion Source. Inside of the ion source, there is an electrically heated filament that provides a source of electrons. As these electrons collide with gas molecules, they split off electrons from the gas molecules and create positively charged gas ions. These ions then encounter the electrostatic fields, established within the ion source by the ion repeller, the ion chamber, the focusing plates and the object plate. The end-result of this arrangement is to accelerate the gas ions into a well defined mono-energetic beam.

MASS SPECTROMETER MAGNETS

Since the gas entering the spectrometer contains atoms and molecules of different kinds, the ion beam will likewise contain a variety of ions including nitrogen, oxygen, carbon dioxide, and, if a leak has been found, helium. Magnets are mounted on the outer portion of the spectrometer, outside of the vacuum system, and are used to create magnetic fields that are perpendicular to the beam of gas ions. A magnetic field causes the ions to deflect off their current trajectories; the amount of deflection depends upon the mass of the gas ion. Lighter ions such as hydrogen are deflected to a greater extent than heavier ions such as oxygen.

Two identical magnetic fields are used in the MS-60's mass spectrometer. The first magnetic field is organized so that only helium has the right mass to pass through the field and through the narrow opening in the baffle on the far side of the magnetic field. Most of the other ions will be deflected in a different direction (they will be either too heavy or too light) and will be intercepted by the baffle. A few of the non-helium ions will be able to pass through the baffle (due to random scattering and bouncing of the ions within the mass spectrometer). Therefore, a second identical magnetic field is used again, which acts to virtually eliminate all ions except for helium ions. By using this construction of two separate magnets and baffles, helium is selectively transmitted to its target, while other gases, even if present in large quantities, are rejected.

ION COLLECTOR

After passing through the magnetic fields and baffles of the spectrometer, the gas ions enter the ion collector. The ions strike a plate known as the **target**. As the helium ion strikes the target, the target becomes positively charged, causing an extremely small electron flow, as low as 1×10^{-15}

Amperes. The current flow is detected and amplified within the collector. The first stage of amplification is within the high vacuum environment to assure stability, minimize the time constant and reduce stray “noise” pick-up. The amplified signal is proportional to the partial pressure of helium within the source. This signal, the actual leak rate, is sent to the MS-60 computer for display on the User Panel.

VALVE BLOCK ASSEMBLY

The valve block assembly consists of:

- Calibrate Valve (with Calibrator Assembly)
- Direct Valve (Fine)
- Vent Valve w/Vent Filter
- Rough Valve
- Rough II Valve (high conductance rough - 11 CFM pump optional only)
- Fore/Rev Valve (Foreline/Reverse)
- Gross Valve
- Sniff Valve (Sniffer) w/Sniff Hose Connection
- Purge Valve w/Purge Hose Connection
- Test Port
- Test Port Pirani
- Internal Mechanical Pump flex Line
- Foreline flex Line

Note that the external rough valve, while part of the vacuum system, is not located on the valve block.

CALIBRATE VALVE

A three-way valve that connects the calibrator to the test port. With the use of a filter, this valve is also used to vent the calibrator to atmosphere.

DIRECT VALVE

Connects the test port to the high-vacuum section. Open during Direct mode testing.

VENT VALVE w/VENT FILTER

Connects the test port to atmosphere through a sintered metal filter that prevents particles from being drawn into the valve block during venting.

ROUGH VALVE

Connects the inlet port to the internal mechanical pump for initial evacuation of the test object.

ROUGH II VALVE

FORE/REV Valve

Connects the foreline of the turbomolecular pump to the internal mechanical pump and is also used in conjunction with the rough valve for Reverse flow testing. This valve is always open on units equipped with an external roughing pump.

GROSS VALVE

Connects the test port to the foreline of the turbomolecular pump (through a restriction). Open during Gross mode testing.

SNIFFER VALVE (Sniffer) w/SNIFF HOSE CONNECTION

Connects the sniffer port to the foreline of the turbomolecular pump. Open during sniff testing. Sniff hose is 1/4" Poly-flo tube fitting and tubing. Connects the rear sniff QCF to the sniff valve.

PURGE VALVE w/PURGE HOSE CONNECTION

Connects the gas ballast port of the internal mechanical pump (through Poly-flo tubing) to atmosphere through a sintered filter that prevents contaminants from being drawn into the internal mechanical pump through the purge valve. Can be connected to dry nitrogen. Opening this valve assists in "purging" the system of trapped gases and "condensable elements" from the pump's oil. Hose is 1/4" Poly-flo tube fitting and tubing. Connects the purge valve to the purge fitting on the internal mechanical pump.

TEST PORT

A standard KF-25 vacuum connection. Used to attach test objects to the MS-60.

TEST PORT PIRANI

A pressure gauge that monitors the test port pressure from atmosphere to 10^{-3} Torr.

INTERNAL MECHANICAL PUMP "FLex" Line

KF16 size stainless steel flex hose. Connects the valve block to the internal mechanical pump.

FORELINE "FLex" Line

KF16 size stainless steel flex hose. Connects the valve block to the foreline of the turbomolecular pump.

PUMPS**EXTERNAL ROUGHING PUMP**

Optional equipment with the MS-60. A 16 CFM dual stage rotary vane (mechanical) pump. The pump is capable of evacuating from atmosphere to 10^{-3} Torr. Assists in providing a leak test range from 10 to 1×10^{-3} std cc/sec helium. The pump is necessary when testing large objects.

INTERNAL ROUGHING PUMP

A 7 CFM (or optional 11 CFM) dual stage rotary vane (mechanical) pump. Used to evacuate the test port and test object. Also used to provide "backing" of the turbomolecular pump.

HIGH VACUUM PUMP

A 60 liters/second turbomolecular pump. In Direct mode testing, the pump allows the MS-60 to measure leak rates as low as 5×10^{-12} std cc/sec helium. In this mode, the test port is directly connected to the high-vacuum system. When performing Reverse mode testing, test port gases are channeled to the foreline side of the turbomolecular pump. The turbomolecular pump acts to

protect the mass spectrometer from these test port gases. Helium molecules however, due to their relatively small mass, are able to “back diffuse” through the turbomolecular pump. Since heavier gas molecules are trapped by the pump, only helium enters the high-vacuum system, where the mass spectrometer is able to accurately measure the leak rate.

GAUGES

TEST PORT PIRANI

A gauge that measures pressures from atmosphere to 10^{-3} Torr in the test port.

FORELINE PIRANI

A gauge that measures pressure at the foreline side of the turbomolecular pump.

CALIBRATORS

The MS-60 uses three separate testing modes (Gross, Reverse and Direct) in order to test leak ranges between 10 std cc/sec to 5×10^{-12} std cc/sec.

GROSS MODE

The Gross mode calibration covers the range between 10 std cc/sec to 1×10^{-6} std cc/sec. The gross valve has a constriction that allows only a small percentage of the test port gas to enter the high-vacuum section and reach the mass spectrometer. If helium is detected, the signal is amplified by the Gross mode Gain (G1) to correct the measurement. An external calibrator is required to perform this calibration.

REVERSE and DIRECT MODES

An internal calibrator that emits helium at a rate between 1×10^{-8} to 3×10^{-8} std cc/sec is standard equipment with every MS-60. External models of differing ranges are also available. Contact VIC for further information.

ELECTRONICS

The MS-60's electronics consists of five separate circuit boards:

- **A board** - controls the unit's main processor, logic and sensors
- **B board** - controls the unit's mass spectrometer voltage supplies
- **C board** - controls the unit's displays and controls
- **Power Distribution board** - controls the power throughout the unit
- **Remote board** - controls the unit's handheld remote (optional).

Service & Maintenance

4.1 INTRODUCTION

This chapter has been divided into three separate sections. The first section describes the different maintenance procedures required by the MS-60. The second section details vacuum system contamination, its causes and effects, and the methods required to eliminate it. The third section provides information on identifying system faults and provides recommended corrections.

4.2 SERVICE MODE

Grouped to the right of the Service mode indicator are a series of LED indicators. The Service mode allows the setting of the unit's parameters like the Amplifier Gain, Plate Voltage, and Internal Calibration Value in conjunction with the arrow buttons and LED alphanumeric display to the right of the indicators. Additionally, the user may view the unit's calibration temperature, the emission current of the filament within the unit's spectrometer, the error code present (indicating a possible fault within the unit), the current supplied to the filament in the mass spectrometer, the calibration standard (e.g., 2×10^{-8} std cc/sec @ 24°C) of the internal calibrator, the leak rate of the test object (a numeric value - the same leak rate as displayed by the bar graph on the User Panel), the pressure measured at the test port, and the total number of hours the unit has been in operation.

Below the indicators and to the right of the valve controls are two sets of momentary switches. In either Standard or Service modes, they allow the User to turn on/off the filament within the mass spectrometer, choose between two different filaments within the spectrometer, and perform an actual test on the calibrator or optimize the mass spectrometer. When strictly in Service mode, the User is also able to choose between either a helium or air standard for leak rate measurement or choose whether the MS-60 will measure either with Mass 3 or 4 helium.



WARNING!

Only qualified service personnel should operate the unit when either the front or rear panels are open. Potentially lethal high voltages are continually applied to the circuit boards and other areas within the unit during its operation. Failure to follow this precaution may lead to severe injury or death.



WARNING!

The Service mode of the MS-60 is intended for use by qualified VIC personnel or Users specifically trained by VIC. Under no circumstances should any individual be assigned access to this mode without a thorough knowledge of vacuum systems as well as the MS-60 System. Use by an unqualified operator may result in damage to the unit and/or personal injury.

NOTE

In Service mode, the MS-60 may be operated as a totally manually operated and sequenced leak detector. In this mode the vacuum system operates without its normal computer protected safeguards. Contamination and/or damage to the unit will occur if the vacuum system is not properly sequenced. If in any doubt, operate the various valves and controls that comprise the vacuum system in the same sequence as the MS-60 operates in its standard/fully automatic mode.

To perform many of the service and/or repair procedures described in this chapter, the MS-60 will have to be placed into its Service mode. Service Mode is initiated by first opening the front panel of the unit (loosen the two 1/4-turn screws at the top of the panel, then gently lower the door), and then pressing the blue pushbutton (SW1) on the A Board.



Once the pushbutton has been pressed, the unit is placed in Service mode and the Service mode indicator is illuminated.

Service Mode disables the automatic valve controls and allows the User to manually control all of the valves within the vacuum system. The valves are controlled by a cluster of labeled momentary switches located on the left of the User Panel. The LED indicator on each switch is lit when the valve is open. The valves included within the vacuum system are cal (calibrator), ext rough (external rough), direct (fine), fore (foreline or reverse), gross, purge, rough, sniff and the vent.



To return to the Standard mode, press the SERVICE pushbutton a second time. The Service mode indicator will be extinguished and the MS-60 will return to its normal operating mode.

NOTE:

After exiting from the Service mode, the MS-60 requires fifteen seconds to accurately acquire background and other system measurements. During this time, the system computer will prohibit any testing from occurring and the system will “beep” whenever the Start switch is pressed. At the end of this fifteen-second time period the READY light will turn on, a test cycle may be commenced normally by pressing the Start switch.

4.3 CALIBRATION & TUNING

The MS-60 may be tuned and calibrated automatically or manually. The automatic (computer assisted) procedures follow:

With the unit in “standby” mode and the test port blanked off, use the following procedure to calibrate the leak detector:

1. Press the CAL CHECK momentary switch. The unit will begin the “calibration check” sequence.
2. The MS-60’s computer will sequence the vacuum system so that:
 - a) the internal leak standard is connected to the test port
 - b) the internal leak standard is then measured by the unit
 - c) the background helium is then subtracted from the initial measurement
 - d) the results of the measurement are then displayed on the leak rate bar graph and numeric display of the user panel

3. The indicator on the CAL CHECK switch will now be flashing. This indicates that the measurement has been completed.
4. The alphanumeric display will now indicate the calculated temperature compensated value of the internal leak rate standard. Compare this with the measurement displayed on the leak rate bar graph and numeric display. If the two readings are within 10% of each other, the unit is considered to be properly calibrated.

If the difference between the two readings is greater than 10%, the measurement gain may be adjusted by pressing the Calibrate button or the leak detector may be re-tuned and re-calibrated by pressing the TUNE button. If the difference between the two readings is acceptable (generally less than 10%) the Cal Check cycle can be ended by pressing the CAL CHECK momentary switch once more.

NOTE

During the warm-up period of the unit (approximately one-half hour), the leak detector's calibration may not be as accurate as during normal operation. When using the MS-60 during warm-up, perform the Cal Check function to ensure the integrity of the unit's measurement accuracy.

Another method of checking calibration is a function exclusive to VIC's MS series of leak detectors: the "Peak Scan" function. Peak Scan allows a user to quickly ascertain if the leak rate indication is due to helium or is if it is the result of a poorly tuned spectrometer. To initiate the Peak Scan function:

1. When the unit is leak testing in Standard mode, press and hold either SELECT momentary switch until the indicator LED for the Plate Voltage function is lit.
2. Press and hold either the left or right "SET" momentary switch. Pressing the left arrow switch will alter the spectrometer peak tuning voltage by -30 volts while pressing the right arrow switch will alter the voltage by +30 volts. Releasing either switch returns the spectrometer voltage back to normal. When this test is made on an optimally tuned spectrometer, the displayed leak rate will decrease to zero indicating that the measurement is actually due to the presence of helium. Both SET buttons should be used for this test.

If the displayed leak rate does not decrease to zero after either SET button is pressed, the spectrometer is not tuned and the TUNE function (see below) must be initiated to retune the mass spectrometer.

To "Tune" the MS-60:

1. When the unit is in Standard mode, press the TUNE momentary switch (located on the left side of the User Panel).
2. The MS-60 will sequence through a full "Auto Tune" cycle. This includes optimizing all mass spectrometer voltages, finding the optimum voltage, measuring background, and adjusting both G3 (direct mode) gain and G2 (reverse mode) gain.
3. When the unit is fully tuned and calibrated, the TUNE indicator light will turn off and the READY LED will be lit.

4.4 PERIODIC SERVICE

Grease Test Port Centering Ring

A properly sealing test port o-ring is essential in assuring rapid pump down of a test object. The o-ring/s should be inspected frequently, at least once each week.

To access the o-ring, remove the 1 1/8" fitting (if equipped) and KF clamp and centering ring atop the test port. With a nonmetallic instrument or by hand, remove the o-ring/s carefully. Be careful not to nick or damage the o-ring/s. Once removed, wipe it with a lint free cloth and inspect it carefully for any damage. Specifically, look for any cuts, wear or flat spots. Replace the o-ring if any damage is observed. Whether installing a new or old o-ring, lubricate the o-ring with a thin film of vacuum grease (Dow Corning vacuum grease is recommended). Re-install the o-ring into the test port. Reattach the centering ring and clamp and screw on the 1 1/8" fitting (if equipped).



Check Oil Level In Internal and External Pumps

The MS-60 is equipped with either one (internal only) or two (internal and external) pumps depending on its configuration. Each pump has a transparent oil level site-glass that allows the user to observe the amount of oil in the pump as well as the oil's coloration.

To observe the oil level, and to access the drain plug and filler port for the internal pump, remove the back cover. The level, plug and filler are on the right side of the pump.



Cover Removal (Straight Blade Screwdriver Required)

- 4 spring lock screws (2 on the side and 2 in the back).
- Pull cover up to remove.

Oil should be added to the pump whenever the oil level window indicates that the pump's oil supply is low. If the oil is darker in color than when initially added to the pump or if the oil is discolored, the oil should be changed. Use only oil recommended by the pump's manufacturer. The procedure for changing pump oil is described later in this section.

Note also that it is possible for the internal pump's oil to become contaminated with helium. Refer to Section 4.5 for the information on indications of helium-based oil contamination.

Check Exhaust Filter On Internal Pump

The internal pump has a disposable exhaust filter. To check the filter, remove the back panel of the unit.



Cover Removal (Straight Blade Screwdriver Required)

- 4 spring lock screws (2 on the side and 2 in the back).
- Pull cover up to remove.

The filter is attached to the top of the mechanical pump. Remove the filter cap by:

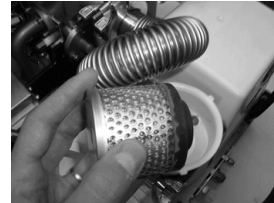
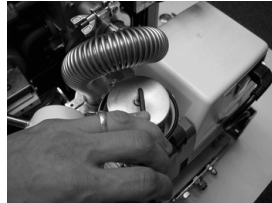

Filter Removal (5/32" Allen Key Required)

- Rotate the filter in a clockwise direction to remove cap (when the cap is removed be sure that the o-ring under the cap is reinstalled when replacing).
- Check the filter, if it is discolored or saturated, replace it with a new filter. Remove the filter by unscrewing the 5/32" Allen key.

The filter medium should be checked periodically and changed according to the manufacturer's instructions.

Changing The Oil In The Pumps

When changing the oil in either the internal or external pump, the oil must be hot to obtain complete drainage. If the oil is not hot, run the pumps for at least fifteen minutes to warm up the oil. However, if the unit, and therefore the pumps, have been running for several hours, it is advisable to shut down the unit and wait several minutes before changing the oil.

The pumps must be shut down to change the oil. Running a pump without a sufficient amount of oil will quickly damage the pump.

To change the oil in the internal rough pump turn off the MS-60. The A.C. power toggle switch is located on the right side of the unit

Remove the back cover.



Cover Removal (Straight Blade Screwdriver Required)

- 4 spring lock screws (2 on the side and 2 in the back).
- Pull cover up to remove.

Drain the oil from the pump.

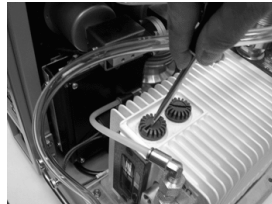
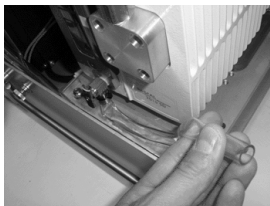

Oil Drain (Straight Blade Screwdriver Required)

- The unit should be located so the oil can drain out of the unit and into a container.
- Locate the drain tube and position over drain container.
- Unscrew the black cap on the pump as shown to quickly drain the oil.
- Open drain cock on the pump to drain the oil.
- After the oil is drained, tighten the drain cock.
- Fold tube so excess oil does not get into the unit.



CAUTION:

Use only a manufacturer's recommended oil or its equivalent. Use of other oils will produce poor pressure performance and rapid contamination. Also, do not use solvents or light flushing oils since complete removal is difficult and its higher vapor pressure prevents attainment of required vacuum.

Oil fill.

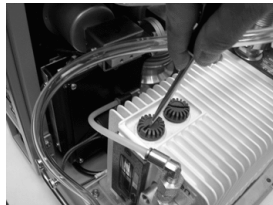

Oil Fill (Straight Blade Screwdriver, Funnel, Oil Required)

- To fill the pump with oil, unscrew the black cap as shown.
- Using the oil (760-54-001) and the funnel (1330-129-00) provided in the installation kit, slowly fill the pump until the level in the sight glass is approximately in the middle of the white bar.
- Replace the black oil fill cap.

Run the MS-60 for at least five minutes. This will circulate oil through the pump and “flush” out any contaminants. If any visible contaminants still appear in the pump oil repeat the oil change steps again until the pump oil appears free of contaminants. Make sure that before the MS-60 is used that the pump is filled with a sufficient amount of oil.

To Change The Oil In The External Rough Pump

1. Turn off the MS-60. The A.C. power toggle switch is located on the right side of the unit. Turn off the power to the external rough pump.
2. Place the pump on a raised flat surface (e.g., a table or workbench) so that the pump's oil drain is over a used oil container.
3. Open the drain valve and wait for the oil to drain out of the pump. In order to quickly drain the oil from the pump; open the fill plug located on top of the pump. Make sure to use a large enough object to collect the oil, removing the oil in this manner may cause the used oil to splash within its container. Once the oil has been completely drained from the pump, replace the drain plug.
4. On the top of the pump is a fill plug. If it has not already been removed, unloosen the plug and with a funnel refill the pump. Pour enough oil into the pump so that the oil level as seen through the sight glass (located on the side of the unit) is midway between the unit's high/low range. Replace the plug.

**CAUTION:**

Use only manufacturers recommended oil or its equivalent. Use of other oils will produce poor pressure performance and rapid contamination. Also, do not use solvents or light flushing oils since complete removal is difficult and its higher vapor pressure prevents attainment of required vacuum.

5. Run the mechanical pumps for at least five minutes. This will circulate oil through the pump and flush out any contaminants. If any visible contaminants still appear in the pump oil repeat the oil fill again until the pump oil appears free of contaminants. Make sure that before the pump is used that it is filled with a sufficient amount of oil.

4.5 CONTAMINATION OF THE VACUUM SYSTEM

All leak detectors are subjected to contamination of the vacuum system by repeated exposure to gases and other matter drawn from test objects during ordinary testing. This matter will settle throughout the vacuum system. Special consideration should always be given for contamination of the mass spectrometer, the oil, and filter of the rotary vane mechanical pump. As a result of contamination, system performance will drop and sensitivity will decrease. Cleaning and re-calibration of the vacuum system is necessary to restore the unit to optimum performance.

Indications of Contamination

The vacuum system is considered contaminated if any of the following conditions exist:

1. The amplifier gain (either G2 or G3) indicator displays a gain of 8 or higher. This indicates that the sensitivity of the mass spectrometer has decreased and the automatic gain compensation of the unit is reaching its limit. Verify tuning by performing the "Tune" function (as described in Section 2.8). If after the Tune function has been performed, the gain value is not lower than previously reported, the mass spectrometer should be removed from the high-vacuum system and cleaned (the procedure is described in Section 4.7).
2. The high-vacuum pressure display is erratic. This can be observed by selecting the High Vacuum function on the Service Panel. This requires that the high-vacuum section be opened and cleaned (this procedure is described in Section 4.7).
3. The plugged test port cannot be pumped to less than 50 millitorr. This condition indicates that the oil in the internal rough pump (or external rough pump, when equipped) may be contaminated and needs to be replaced (this procedure is described in Section 4.4).
4. The foreline pressure cannot be pumped to less than 50 millitorr. This condition indicates that the oil in the internal rough pump may be contaminated and needs to be replaced (this procedure is described in Section 4.4).
5. With the test port plug in place, the leak rate indicator does not reach a "zero" reading even after prolonged pumping. This condition indicates that the accumulated contaminants within the unit have absorbed a high amount of test helium. When this occurs, place the unit in its "standby" mode for a minimum of three minutes. The unit will be able to pump away some of the background helium and to take new measurements. Re-testing of the test object is recommended at this point. If the situation is still not remedied, changing the oil in the internal rough pump as well as a system-wide cleansing of the internal components of the unit may be needed.

Note that it is possible that the symptoms listed above may also be due to causes other than contamination. The following problems should be considered and eliminated prior to proceeding with contamination-related service:

- Leak in the vacuum system.
- Incorrectly tuned spectrometer.
- Malfunctioning turbomolecular pump.

Sensitivity Check

A sensitivity check provides an indication on how the leak detector is responding to repeated exposure to gases drawn into its vacuum system. Matter contained in these gases tends to contaminate the mass spectrometer and reduce its sensitivity. The unit's computer senses this reduction and automatically compensates for this loss by increasing the helium signal amplifier gain (the Amplifier Gain function divided into G2: gain during Reverse mode testing or G3: gain during Direct mode testing). If the unit is left unserviced, through continuing computer adjustment in response to increasing contamination, the "reserve" gain will eventually be exhausted. A cleaning and re-calibration of the mass spectrometer components is necessary to prevent this condition.

A sensitivity check is made by pressing the SELECT momentary switches on the Service Panel until the AMP GAIN function is reached. As stated above, five Gain measurements are available: **G1, G2, G3, G4** and **G5**. **G1, G4** and **G5** are user-settable, so a high value of this gain is not necessarily an indication of contamination. The SELECT switches are also used to toggle between the five values. The scale of amplifier gain is from 0.01 to 10. Typical gains for a clean system is:

- **G2: 1 - 2**
- **G3: 2 - 4**

As the system progressively becomes more contaminated, the gain also increases (becomes closer to 10).

To correct this condition, the **Tune** function must be used (as described in Section 2.8). If the Tune function has been performed, and either G2 or G3 value is greater than 8, the mass spectrometer assembly should be removed, cleaned and re-calibrated as described in Sections 4.7 and 4.8.

Internal Rotary Vane Pump Oil Contamination

Repeated exposure to high levels of helium, particularly when testing objects with large leaks, may cause the mechanical pump's oil to become contaminated. Helium, along with other gases, become dissolved in the oil and trapped in the internal mechanical pump. This type of contamination is found when:

- A high background of helium is measured that cannot be pumped away.
- An unstable leak rate caused by excess helium that is released from the internal mechanical pump at regular intervals.

A high background level of helium will prevent the MS-60 from testing in its most sensitive ranges. An unstable leak rate will complicate testing and will make the tuning and calibration functions unreliable.

The gas ballast may be opened periodically to “de-gas” the pump’s oil. This should be done only if the background helium rate is excessive or if the leak rate becomes unstable as a result of helium loading. The pump gas ballast is connected to a “purge” valve in the vacuum system, which allows the ballast to be opened to atmosphere through a sintered filter.

The pump may be purged either to atmosphere through the sintered filter, or with dry nitrogen. Dry nitrogen is recommended in areas with high ambient helium and purging the internal pump with dry nitrogen will help prevent contamination. The dry nitrogen supply should be limited to 0.5 to 1.5 PSI so that only a gentle stream of nitrogen enters the ballast port. Nitrogen is connected through a 1/4” bulkhead marked N2 on the rear panel.

To open or close the gas ballast, press the purge momentary switch on the Service Panel (left side of User Panel). The purge valve may only be opened when the unit is in “standby” mode (the READY light will be lit on the User Panel). The ballast should be kept open for a minimum of three minutes to allow the helium to be completely expelled from the oil. The purge valve will automatically close after five minutes, or when the START switch is pressed. The computer will prevent any testing for fifteen seconds after the purge valve closes. This allows the background level to settle and the computer to update the background information.

Occasionally, the internal pump’s oil will become saturated with helium to the point that purging with dry nitrogen and “de-gassing” the oil through the gas ballast will not be entirely effective. If the background and instability problems are not sufficiently solved through these measures, change the pump’s oil (refer to Section 4.4 for this procedure).

4.6 VENTING THE VACUUM SYSTEM

Cleaning, service and repair of vacuum system components usually requires the venting of the Vacuum System. Venting is always necessary for removal of component parts. Service must be performed by adhering to procedures that minimize the pump down time when the system is restarted (e.g., using latex gloves when touching internal equipment - without gloves, the fingerprints left behind are a source of out gassing and contamination that effect the efficiency of the MS-60).



WARNING!

Venting of the Vacuum System should be performed by qualified personnel only. Improper sequencing of the vacuum system may lead to damage to the unit or injury to service personnel.

To Vent the Vacuum System:

1. Place the unit in Service mode. Service mode is initiated by first opening the front panel of the unit (loosen the two 1/4-turn screw at the top of the panel, then gently lower the door), and then pressing the blue pushbutton (SW1) on the A Board.



Once the pushbutton has been pressed, the unit is placed in Service mode and the Service mode indicator is illuminated.

2. From the valve section of the Service Panel, close all valves except the fore (foreline) valve.
3. Press the ZERO momentary switch located on the User Panel. This will shut down the turbomolecular pump. Wait three minutes for the turbomolecular pump to spin down.
4. Press the FORE momentary switch on the Service Panel to close the foreline valve.
5. Remove the back cover



Cover Removal (Straight Blade Screwdriver Required)

- 4 spring lock screws (2 on the side and 2 in the back).
- Pull cover up to remove.

6. Turn off the power to the internal rotary vane pump by disconnecting the pump's power cord.
7. Open the vent valve by pressing the momentary switch on the Service Panel.
8. Open the direct (fine) valve by pressing the momentary switch on the Service Panel. The turbomolecular pump will rapidly decelerate (this produces a highly distinctive noise).
9. Open the fore (foreline) valve by pressing the momentary switch on the Service Panel. This vents the mechanical pump.
10. Close the vent, direct and fore valves.
11. Turn off the unit.

To restart the MS-60, reconnect the internal pumps power cord and perform a normal start-up procedure (as stated in Section 2.3).

4.7 CLEANING REQUIREMENTS

When it has been determined that the vacuum system is contaminated, components of the vacuum system will need to be cleaned and serviced as stated in the remainder of this section. Since contamination should not be a frequent occurrence, it is recommended that as many as possible of the components listed in this section be cleaned and/or serviced at the same time.

Parts that require cleaning are:

- Mass Spectrometer (including the source, collector and housing).
- Turbomolecular pump.
- Vacuum system valves.

To obtain complete and unimpeded access to the internal systems of the MS-60 remove the top cover, and lower the front panel.



Cover Removal (Straight Blade Screwdriver Required)

- 4 spring lock screws (2 on the side and 2 in the back).
- Pull cover up to remove.



Front panel Opening (Small Phillips Head Screw Driver Required)

- Loosen the two 1/4-turn screws at the top of the panel, and then gently lower the door.

Cleaning Procedure for Contaminated Parts

Whenever the vacuum system becomes contaminated, it will be necessary to disassemble and clean all components that are affected. Cleaning procedures for vacuum apparatus such as electron tube parts, test chambers, etc., are generally appropriate for cleaning MS-60 vacuum components.



WARNING!

At all times, the inhalation of cleaning fluid vapors must be avoided. Also, extreme care should be taken with flammable substances such as acetone.

**NOTE**

When handling any components normally exposed to vacuum, use only lint-free gloves. Touching any object with bare hands will leave an organic residue on the component that will out gas and negatively effect the subsequent leak detection procedure.

The solvents referred to in this section are Freon and acetone. Acetone is used whenever large deposits of grease or oil are to be removed. Remember, however, to use acetone in a well ventilated area. Since acetone is highly flammable, all standard safety precautions when dealing with flammable substances should be taken whenever acetone is used.

Immerse components in a cleaning solvent for five minutes. Thoroughly rinse in hot water and dry immediately. Heating the components, prior to re-assembly is the final stage of cleaning.

**NOTE**

Never remove o-rings with a metal tool, as this could scratch the o-ring groove, and cause a leak. Use a plastic or wooden (or any soft material) tool to remove the o-ring by inserting the tool between the inside of the o-ring and its groove and then sliding the tool around the inside of the o-ring. This will cause the o-ring to pop up. An o-ring may have to be held on its opposite side to prevent its turning in the groove. This procedure usually gives much better results than trying to pry the o-ring from its groove.

O-rings are susceptible to absorbing large quantities of the solvents used in cleaning. Subsequent evaporation of these solvents when the system is later evacuated (during testing) must be avoided. Therefore, o-rings and gaskets should be removed from flange grooves and treated as a separate cleaning problem. O-rings and gaskets are either replaced at the time of re-assembly (recommended), or carefully wiped clean with a lint-free material and inspected for surface damage of any kind before they are used again. If a new o-ring is used, it should be wiped clean, inspected and lubricated with a light film of vacuum grease and essentially the same procedure as would take place when reusing an old o-ring. Use vacuum grease as sparingly as possible since it later may become a source of system contamination.

Cleaning the Mass Spectrometer Assembly - Refer to exploded view on the next page

1. Refer to Section 4.9 for an explanation of how to remove the spectrometer assembly from the MS-60.
2. Disassemble the two half sections of the spectrometer housing and remove the center slit plate and o-ring.
3. Clean the two sections. The interior of both sections should be lightly sanded or bead blasted to remove all stains. Blow out the bead blast residue with dry, oil-free air. The sections should then be cleaned ultrasonically in Freon and dried with a hot air gun. Make sure to handle the sections when wearing lint free gloves. Reassemble the two sections and install a new o-ring.

The source may be cleaned as follows

1. Remove the source's o-ring and wipe away any excess grease from the o-ring groove.
2. Remove the source's filaments as stated in the Section 4.9. Clean the area using a fine emery cloth held with needle nose pliers or tweezers. Be careful to not use excessive force; any bending or shifting of the filament area may cause an electrical short. Rinse the source in Freon and clean it ultrasonically. Install new filaments as described in Section 4.9.

The collector may be cleaned as follows

1. Remove the collector's o-ring and wipe away any excess grease from the o-ring groove.
2. Clean ultrasonically in boiling Freon for two minutes.
3. Bake the entire assembly at 50°C for 30 minutes.
4. Apply a light film of vacuum grease on the o-ring and reinstall the collector assembly into the mass spectrometer.

MS-60 Mass Spectrometer

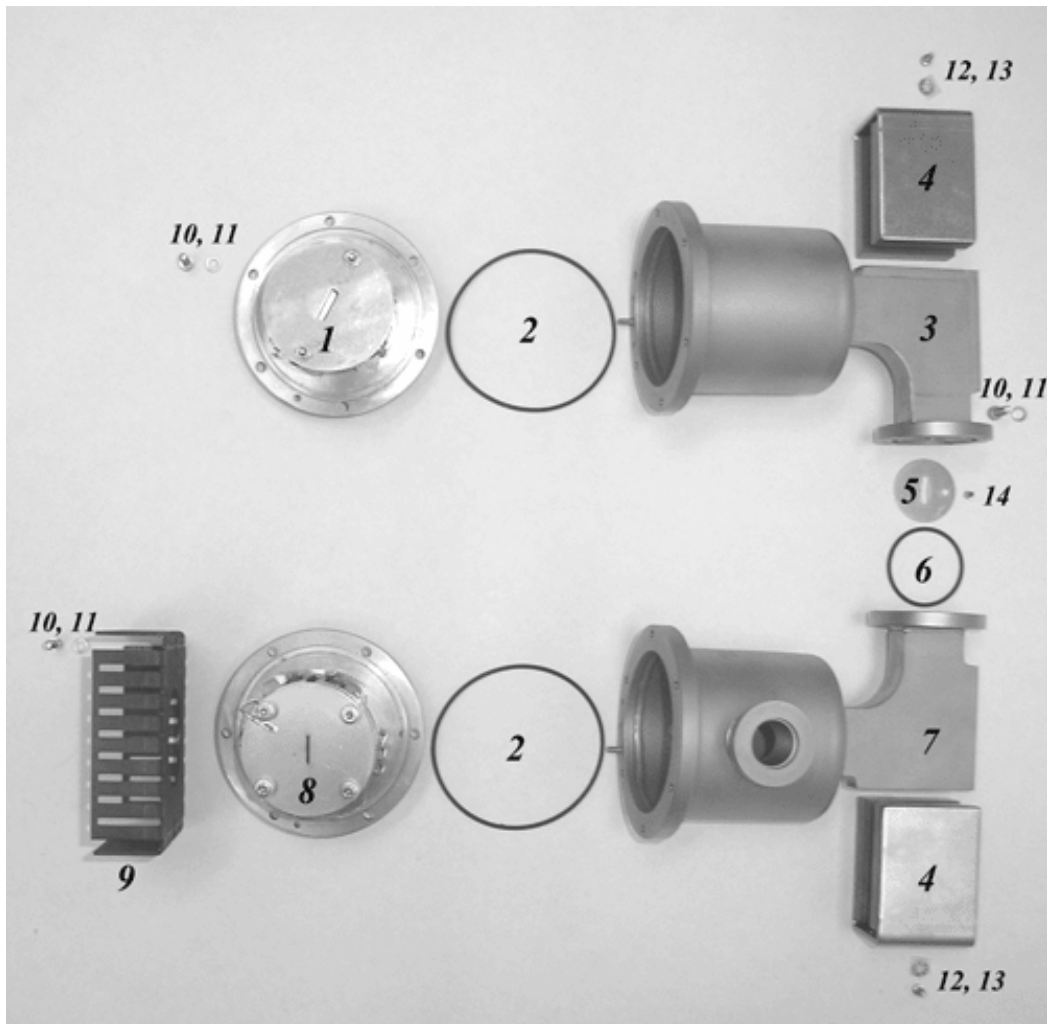

Item #	VIC P/N	Description
1	0136-051-00	Collector Assembly
2	0011-037-00	O-ring, 2 1/2 x 1/16
3	0135-053-00	Collector Body
4	0130-151-03	Magnet
5	0130-195-00	Slit Plate
6	0011-024-00	O-ring, 1 1/8 x 1/16
7	0137-011-00	Source Body
8	0137-014-00	Source Assembly
9	0137-232-00	Heat Sink
10	Commercial	Screw, Socket Head, #6-62 x 1/2
11	Commercial	Lockwasher, Split #6
12	Commercial	Screw, #40 x 3/8
13	Commercial	Lockwasher, Split #4
14	0130-168-00	Screw, Vent, #2-56 x 3/16

4.8 CALIBRATION REQUIREMENTS

Calibration is required when components associated with a measurement function are serviced, repaired or replaced.

The items that need to be calibrated and reset after service, repair or replacement are:

- Test port and foreline Pirani gauges.
- Hi-Vac gauge.
- Temperature sensor.

Test Port Pirani Calibration

NOTE

Calibration is required whenever a gauge is replaced.

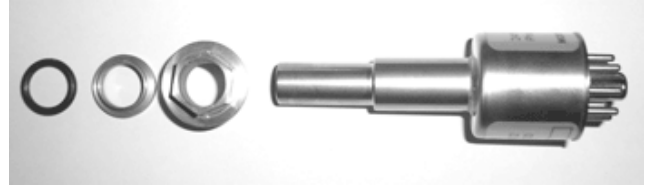

1. Ensure that a blank plug is attached to the test port and that all valves except the fore (foreline) valve are closed. Verify that the MS-60 is in the Standard mode.
2. Open the front panel and gently lower the door.



Front panel Opening (Small Phillips Head Screw Driver Required)

- Loosen the two 1/4-turn screws at the top of the panel, and then gently lower the door.
3. Using either of the SELECT arrow keys on the left side of the User Panel, select the Test Port Pressure function. The function has been selected when the green indicator light to its left is lit.
 4. Set the unit to manually range down to 10^{-10} range (to ensure that the unit is in Direct mode) by pressing the auto/manual momentary switch so that the manual ranging mode is initiated and then pressing the “down arrow” key so that the “10 range” is selected as the eventual “pump down” goal.
 5. Press the START pushbutton to start the test cycle. Allow the unit to pump down so that it reaches Crossover **D**. The direct valve opens (the green indicator next to direct valve on the Service Panel will be lit).

6. On the “A” board mounted on the interior of the front door, adjust the RT4 potentiometer (at the bottom center of the board) so that the test port pressure is reading 4 millitorr on the alphanumeric display. The optimal method is to adjust the potentiometer too slightly greater than 4 millitorr, then slowly turn the potentiometer down until the display just indicates 4 mTorr. When the unit is vented, the indication should read 760000 mTorr.

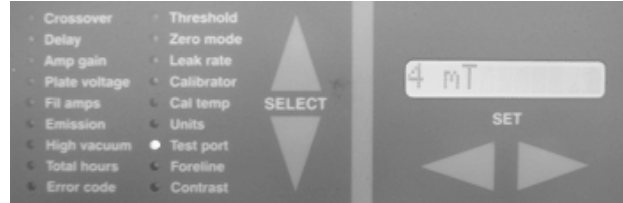
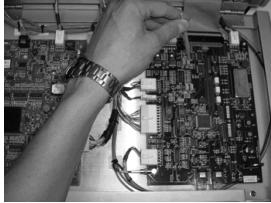

NOTE

Be careful not to over-adjust this setting, while the potentiometer can be set to a value less than 4 mTorr, the alphanumeric display will still indicate a reading of 4 mTorr.

Foreline Pirani Calibration

NOTE

Calibration is required whenever a gauge is replaced.



1. Ensure that a blank plug is attached to the test port and that all valves except the fore-line valve are closed. Verify that the MS-60 is in the Standard mode.
2. Open the front panel and gently lower the door.



Front panel Opening (Small Phillips Head Screw Driver Required)

- Loosen the two 1/4-turn screws at the top of the panel, and then gently lower the door.

NOTE

The test port Pirani must be calibrated prior to calibration of the foreline Pirani.

3. Using either of the SELECT arrow keys on the Service Panel, select the TEST PORT (pressure) function. The function has been selected when the green indicator light to its left is lit.
4. Set the unit to manually range down to a decade that the unit will run in while in Reverse mode (e.g., the 10^{-8} range). Make sure not to range down too far (e.g., if you range down to the 10^{-10} range then up to the 10^{-8} range, the unit will be in direct mode instead of Reverse mode). Wait until test port pressure stabilizes. Record the test port pressure.
5. Using either of the SELECT arrow keys on the left side of the User Panel, select the FORE-LINE function so that foreline pressure reading appears on the alphanumeric display.

6. On the "A" board mounted on the interior of the front door, adjust the **RT5** potentiometer until the foreline pressure reading is the same as the test port pressure reading recorded in Step 4.
7. Re-select the TEST PORT function. Verify that the test port pressure is still the same as recorded in Step 4. If the reading has changed, repeat the procedure until the foreline pressure and test port pressure match.

Calibration of the High Vac Gauge. (The test port Pirani calibration must be verified first according to the manual)

The high vacuum "gauge" in an MS-60 is an integral part of the Source Assembly in these units, and it works by monitoring the beam of ions that is generated in the source. This beam is accelerated into the magnetic field for separation to detect helium. The top plate, which previously was a ground plate that accelerated the ions now is isolated and monitored by a "meter" circuit. The ions at the edge of the beam strike this plate and are collected and amplified to provide a means of measuring the total pressure in the spectrometer.

As there are small physical differences from source to source this current will not be exactly the same for each machine and must be calibrated. This is done initially at the factory but may have to be re-calibrated when filaments are replaced or the source is rebuilt. The procedure follows:

1. Make sure that the MS-60 is in the Service mode, the filament is off, the source is disconnected and only the fore (foreline) valve is open.
2. Open the vent valve. Install a closed variable leak valve in the test port. Close the vent valve.
3. Close the fore (foreline) valve. Open the rough valve.
4. When the test port pressure reads 20 mTorr or less, open the direct (fine) valve, then open the fore (foreline) valve. Close the rough valve.
5. Make sure the filament is still off. Plug in the source connector.
6. Slowly open the variable leak until the test port pressure is reading 23 to 28 mTorr (use the digital readout of test port pressure on the display).
7. Select high vacuum on the alphanumeric display. Turn on the filament.
8. Adjust the high vacuum pressure reading to 4.7 to 4.9 x 10⁻⁴ Torr using the only potentiometer on the B Board - RT2.
9. Close the direct (fine) valve. Open the vent valve and remove the variable leak. Blank off the test port.
10. Put the MS-60 into normal operating mode.
11. Make sure that the filament is turned ON.

Generally if the machine powers up and the high vacuum is <4X10⁻⁵ after ½ hour the gauge is close to being accurate and may not need re-calibration.

Calibrating the Temperature Sensor

1. Ensure that the unit is in Standard mode. Open the front panel and gently lower the door.



Front panel Opening (Small Phillips Head Screw Driver Required)

- Loosen the two 1/4-turn screws at the top of the panel, and then gently lower the door.

2. Connect a temperature probe to the temperature sensor located on the body of the internal calibrator.
3. Using either of the SELECT arrow keys on the Service Panel, select the CAL TEMP function so that the temperature reading appears on the alphanumeric display.



NOTE

The temperature probe should have a resolution of 0.1°C.

4. On the "A" board mounted on the interior of the front door, adjust the **RT1** potentiometer until the temperature reading on the alphanumeric display matches the temperature indicated by the temperature probe.

4.9 GENERAL SERVICE & REPAIR

Servicing the Valves

The most likely cause for a leaky vacuum system is faulty valve closure. A valve seat and seal become dirty or contaminated with use, causing small leaks that must be corrected for the leak detector to function as required. The valves must be cleaned when a leak develops or the system becomes contaminated as described in Section 4.5. If a valve seal is damaged the valve should be replaced.

Generally, valves exposed to low pressure and high flow are most likely to be the cause of a leak and should be serviced first. Cleaning procedures are discussed in Section 4.7.

All valve servicing is performed while the unit is in Service mode. In order to easily access the valve block the front panel needs to be opened.

**CAUTION:**

Do not use metal tools or sharp objects to inspect a valve seat in the valve block. Any scratch will irreparably damage the seat.

Servicing the Fine, Vent, Rough, and Fore Valves

1. Vent the entire system. Follow the procedure stated in Section 4.6.
2. Remove the two wires from the valve. Make note of which wire is connected to each metal prong.

Valve	Top Prong	Bottom Prong
Direct (Fine)	Brown/White	Red
Vent	Yellow/White	Red
Rough	Black	Blue
Fore	Orange/White	Red

3. Remove the four screws and remove the valve.

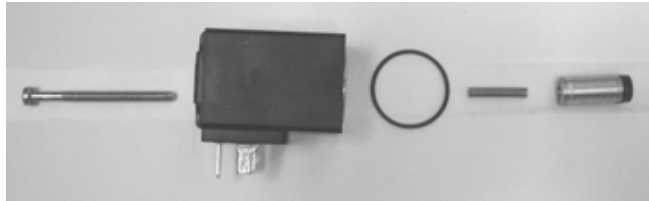

4. Remove the plunger and the seal assembly from the valve coil. Wipe only the outer area of the plunger seal. Do not remove this seal.
5. The valve's o-ring is in the manifold block for the Direct (Fine), Rough & Fore and the body of the valve for the Vent. Remove it with a plastic or other non-metallic instrument. Do not use metal or any other "hard" instruments as they may scratch the o-ring groove. Wipe each o-ring with a lint-free cloth and check each carefully for nicks, dents or flat spots. Replace when necessary.
6. Wipe the seat on the valve block with a clean, lint free cloth to remove any contaminants. If necessary, a small amount of alcohol may be used on the valve block.

**CAUTION**

Acetone or alcohol is destructive to rubber surfaces such as the valve's o-ring. When cleaning rubber surfaces use a clean and dry lint-free cloth.

7. Wipe the o-ring with a clean, lint-free cloth, then coat it with a thin film of vacuum grease (Dow Corning High Vacuum Grease is recommended) and reinstall. The coating should be thin enough so that the grease is barely visible except for leaving a glossy coat on the rubber.
8. Wipe the rubber seal on the end of the valve plunger with a clean, lint-free cloth. Coat the rubber with a thin film of vacuum grease.
9. Replace the spring into the plunger.
10. Replace the plunger into the valve coil.
11. Replace the valve assembly onto the valve block. Be very careful not to pinch the o-ring.
12. Reattach the four screws.
13. Reattach the two wires onto the proper electrical connectors.

Servicing the Gross and Sniff Valves

1. Vent the entire system. Follow the procedure stated in Section 4.6.
2. Remove the two wires from the valve. Make note of which wire is connected to each metal prong.

Valve	Top Prong	Bottom Prong
Gross	Blue/White	Red
Sniff	Purple/White	Red

3. Remove the locking nut and valve coil.
4. The valve is held to the manifold with two screws and the valve assembly is held together with the other two screws. Remove the top left and bottom right screws that hold the valve to the manifold.
5. Remove the o-ring around the valve shaft and remove the two screws holding the valve together.
6. While using lint-free gloves, remove the two o-rings with a plastic tool. Do not use metal or any other hard instruments as they may scratch the o-ring groove. Wipe each o-ring with a lint-free cloth and check each carefully for nicks, dents or flat spots. Replace when necessary.

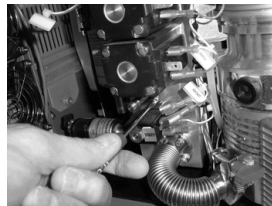
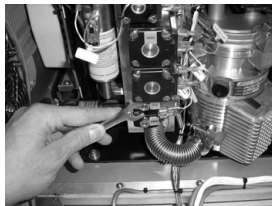

7. Coat each o-ring completely with a very thin covering of vacuum grease (Dow Corning High Vacuum Grease recommended). The coating should be thin enough so that the grease is barely visible except for leaving a glossy coat on the o-ring.
8. With a lint-free cloth wipe off any grease or dirt on the o-ring seats.

9. With even pressure replace the o-rings into their respective o-ring seats. Make sure that each o-ring is securely mounted. Failure to mount the o-ring properly will cause the valve to malfunction or fail completely.
10. Re-attach the valve coil and with the two screws removed in Step 3.

Servicing the Cal Valve

1. Vent the entire system. Follow the procedure stated in Section 4.6.
2. Remove the vent filter fitting.
3. Remove the locking bolt.
4. Remove the top left and bottom right screws that hold the valve to the manifold.
5. While using lint-free gloves, remove the two o-rings with a plastic tool. Do not use metal or any other hard instruments as they may scratch the o-ring groove. Wipe each o-ring with a lint-free cloth and check each carefully for nicks, dents or flat spots. Replace when necessary.

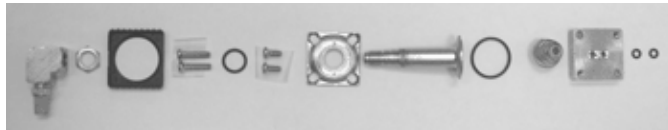

6. Remove the restrictor plate from the valve. Special attention should be given to the hole at the mid-point of the restrictor plate. It is very small and this passage must not be impeded in any way if the MS-60 is to function properly. Clean the restrictor plate and its seat with a lint-free cloth. The coating should be thin enough so that the grease is barely visible except for leaving a glossy coat on the plate.
7. Coat each o-ring completely with a very thin covering of vacuum grease (Dow Corning High Vacuum Grease recommended). The coating should be thin enough so that the grease is barely visible except for leaving a glossy coat on the o-ring.
8. With a lint-free cloth wipe off any grease or dirt on the o-ring seats.
9. With even pressure replace the o-rings into their respective o-ring seats. Make sure that each o-ring is securely mounted. Failure to mount the o-ring properly will cause the valve to malfunction or fail completely.
10. Re-attach the valve coil and restrictor plate with the two screws.

Replacing the Filaments

To replace burned out filaments, the MS-60 must be vented to permit the removal of the source from the mass spectrometer. The procedure to replace the filaments is:

1. Vent the entire system. Follow the procedure stated in Section 4.6.
2. While holding the source assembly, gently pull off the source electrical connector.
3. Loosen the four screws that hold the heat sink onto the source assembly. Remove the four screws and pull the heat sink off the source assembly.
4. Loosen and remove the remaining two screws holding the source assembly in place.
5. Remove the source assembly.
6. On the source assembly, remove the two outer nuts that hold the filament contacts in place.
7. Gently bend the filament contacts away from the source assembly.
8. Remove the two nuts that hold the ceramic spacer in place. Remove the spacer.
9. Remove the filament assembly.

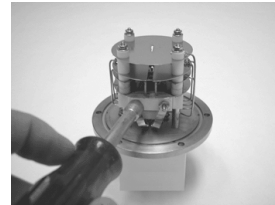
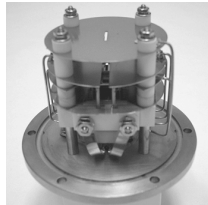
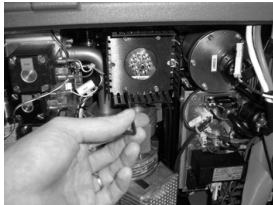

Installation:

1. Carefully bend both filament contacts slightly more than 90° away from the filament side of the assembly.
2. Place the filament on the source assembly. Guide the contacts with the slots provided on the ceramic block.
3. Place the ceramic spacer on the source assembly. Reattach the spacer with the nuts removed in Step 8 above.
4. Slide the filament up or down in the slots of the ceramic block until the top edge of the filament is aligned with the center slit of the source assembly.

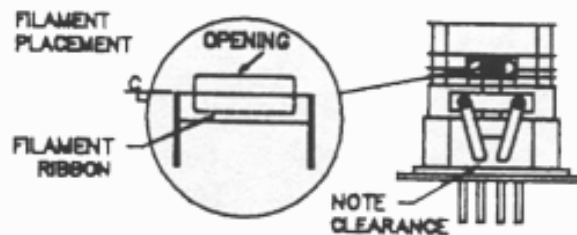

5. Lightly tighten the nuts removed in Step 6 above so that the filament assembly is secured to the source housing.

NOTE

Do not over-tighten the nuts. Over tightening will cause the ceramic block to crack.

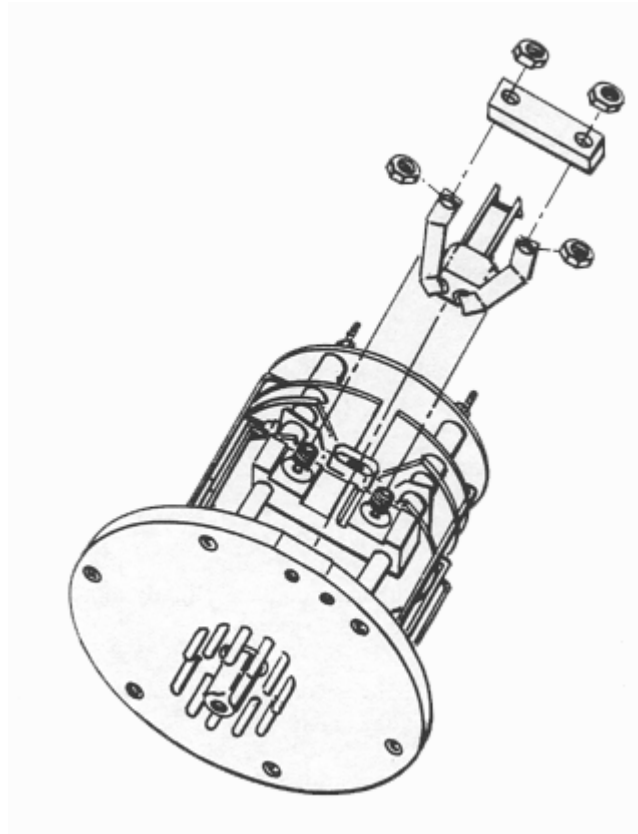

6. Bend the filament contacts so that they touch the stud posts of the source. Make sure that the nuts holding the contacts are tight.
7. Remove the o-ring from bottom of the source assembly. Clean with a dry cloth. Refer to Section 4.7 for information on how to remove, clean and install o-rings.
8. Apply a thin coating of vacuum grease and reinsert the o-ring back into the o-ring slot.
9. Reattach the source assembly into the machine with the two screws removed in Step 4 of Replacing the Filaments.
10. Reattach the heat sink that covers the source assembly with the screws removed in Step 3 of Replacing the Filaments.
11. Reattach the source electrical connector to the source assembly.

Replacing the Internal Leak Standard

The internal leak standard, installed in the MS-60 at the factory, should be returned annually to VIC for re-certification (contact the Customer Service department for information).

The procedure for replacing the internal leak standard is:

1. Turn off the MS-60.
2. Open the front panel.



Front panel Opening (Small Phillips Head Screw Driver Required)

- Loosen the two 1/4-turn screws at the top of the panel, and then gently lower the door.

3. Unscrew the temperature sensor from the calibrator body.

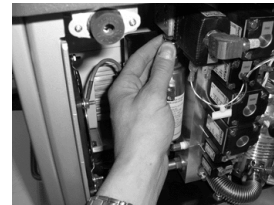
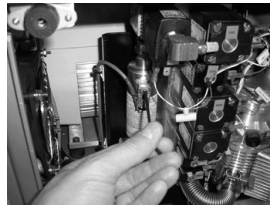

Temperature Sensor Removal (7/64" Allen Key Required)

- Loosen screw to remove sensor.

4. Push the quick release button on the calibrator body to remove the calibrator.
5. Insert new leak standard, a positive click indicates that the standard has been correctly installed.
6. Reattach the temperature sensor onto the calibrator body.

Circuit Board Replacement

The MS-60 contains six circuit boards in the unit and one circuit board in the optional hand held remote. Circuit board A & B are mounted on the inside of the unit's front panel, circuit board C and the LED/Membrane board are located underneath and attached to the User Panel, the power distribution circuit board is located underneath the collector assembly, the Connector Panel circuit board is connected on the side of the unit and the Remote Box Board is the board inside the optional handheld remote box.

WARNING!

The MS-60 must be turned OFF and disconnected from the electrical supply prior to any repair or replacement of any of the circuit boards. When the unit is powered ON, potentially lethal high voltages are continually applied to the circuit boards and other areas within the unit during its operation. Failure to follow this precaution may lead to severe injury or death.



To replace Circuit Board A:

1. Open the front panel by turning the captive screws at the top of the panel 1/4 turn counterclockwise and gently lowering the door.
2. Remove all of the electrical connectors from the board.
3. Loosen and remove the screws that hold down the board. Remove the board.
4. Place the new circuit board on the door. Re-attach the board to the door with the screws removed in Step 3.
5. Re-attach the electrical connectors removed in Step 2.

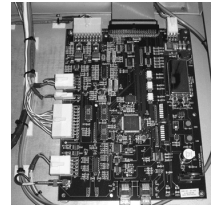

To replace Circuit Board B:

1. Open the front door of the unit by turning the captive screws at the top of door 1/4 turn and then gently lowering the door.
2. Remove all of the electrical connectors from the board.
3. Loosen and remove the screws that hold down the board. Remove the board.
4. Place the new circuit board on the door. Re-attach the board to the door with the screws removed in Step 3.
5. Re-attach the electrical connectors removed in Step 2.

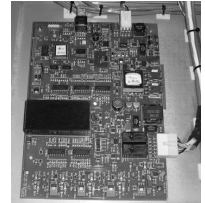

To replace Circuit Board C and the LED/Membrane:

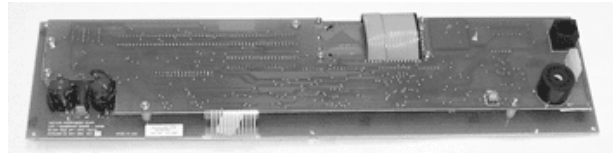
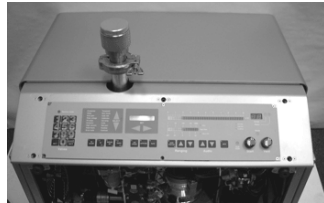

1. Grasp the plastic cover and pull up. Cover is held on with push on connectors.
2. Loosen and remove the screws that hold down the Service/User Panel.
3. Disconnect the electrical connectors going to the boards. The boards can be removed from one another, but it recommended to replace as an assembly.
4. Re-connect the electrical connectors on the new boards and place the new user panel in place.
5. Re-attach the user panel with the screws removed in Step 2.
6. Re-install the plastic cover by snapping in place.

To replace Power Distribution Board:

1. Open the front door of the unit by turning the captive screws at the top of door 1/4 turn and then gently lowering the door.
2. Remove all of the electrical connectors from the board.
3. Loosen and remove the screws that hold down the board. Remove the board.
4. Place the new circuit board in place and re-attach the board with the screws removed in Step 3.
5. Re-attach the electrical connectors removed in Step 2.

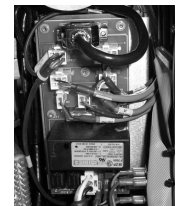

To replace Remote Box Board:

Replacement of the entire handheld remote assembly is required.



Replacing the Turbomolecular Pump

The turbopump is not a serviceable part. It must be sent back to VIC if it has been determined that the pump is in need of repair. For questions regarding replacing the turbomolecular pump, contact the Customer Service Department at Vacuum Instrument.

To replace the pump:

1. Vent the MS-60 (as stated in Section 4.6).
2. Open the front door of the unit.



Front panel Opening (Small Phillips Head Screw Driver Required)

- Loosen the two 1/4-turn screws at the top of the panel, and then gently lower the door.

NOTE

Please note the alignment and orientation of all parts removed. Proper alignment is critical when replacing the components removed in this procedure.

3. Disconnect the electrical connectors to the source and collector on the mass spectrometer.
4. Remove the KF clamp and centering ring from the pump.

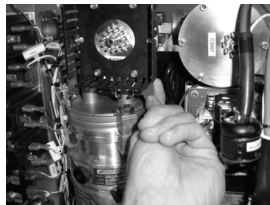

5. Remove the spectrometer assembly from the machine and place in a clean dry area.
6. Disconnect the KF clamp and centering ring from the bottom of the turbo pump.



7. Remove the electrical connector from the turbo pump to the power distribution board. Note you may have to cut tie wraps to remove the connector completely form the unit.



8. Remove the turbo pump from the manifold assembly by unloosening and removing the four 9/64" Allen Screws on the top of the turbo pump.

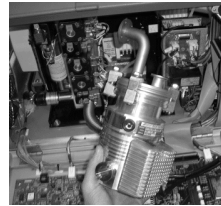
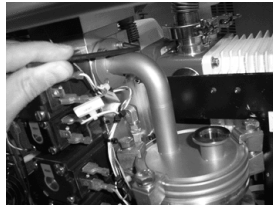

9. Remove the turbo pump from the unit and place in a clean dry area.
10. Note the orientation of the claw clamps that connect the turbo pump to the vacuum manifold for re-installation.



11. Loosen the nuts on the claw clamps. Remove the clamps. Make sure to record the position of each clamp.
12. Lift off the manifold and the centering ring between the pump and the manifold. Place on a clean, flat surface.
13. Refer to the instructions in the Manufacturer's Manual for cleaning the pump. Pump service should be limited to cleaning procedures only - additional work performed on the pump may void the warranty.
14. Clean and lightly grease the o-ring on the large centering ring assembly as necessary.
15. Replace all of the claw clamps removed in the same positions from which they were removed earlier.
16. Position the pump and manifold back into the unit and tighten the 4 9/64" Allen screws.
17. Clean and lightly grease the o-ring on the KF16 centering ring for the spectrometer tube assembly as necessary. Replace the KF-16 clamp and centering ring onto the turbomolecular pump.
18. Reconnect the electrical connector to the source and collector on the mass spectrometer.
19. Reconnect the electrical connector to the turbomolecular pump to the power distribution board.

4.10 TROUBLESHOOTING AIDS

The MS-60 computer's function is to continually monitor the system status and operational data. If an error is detected, it will immediately display that error on the User Panel. If any part of the leak detector's equipment needs to be shut down or if its operation needs to be altered in any way, the computer will instantaneously perform the function.

The Error Code will appear on the User Panel. Specifically, the error code **EE** appears in the numeric display of the User Panel. At the same time, the alphanumeric display on the Service Panel indicates the specific Error Code (e.g., ERROR 08).

The following table lists and describes the unit's error or fault and explains the unit's reaction to the problem. Also included in the table are the probable causes and recommended corrective actions necessary for repair of the unit.

Table 4-1: MS-60 Error Codes

Error Code/Explanation	System Response	Probable Cause	Corrective Action
<p>ERROR 01: Foreline Maximum Error.</p> <p>Foreline Pressure has exceeded 8,000 milliTorr</p>	<p>System senses high pressure in the foreline region. The unit has switched off the filament, closed all valves except the foreline valve and has shut down the turbomolecular pump. The system will wait 20 seconds and will determine if the pressure in the foreline section has dropped below 100 milliTorr. If the pressure has not dropped, the system will repeat this procedure ten times. If the pressure is still too high the unit will shut off.</p>	<ol style="list-style-type: none"> 1) Vacuum System Leak. 2) Crossover 1 is set too high for the size of gas load of the test object. 3) Uncalibrated foreline Pirani. 4) Defective circuit board A. 	<ol style="list-style-type: none"> 1) Isolate and repair leaking valve or O-ring. 2) Lower the Crossover 1 set point and increase the Reverse Rough Delay (D7). 3) Calibrate the foreline Pirani. 4) Replace circuit board A.
<p>ERROR 02: Hi-Vac Error</p> <ol style="list-style-type: none"> 1) High-vacuum section pressure higher than 5×10^{-4} Torr in testing mode. 2) High-vacuum sections pressure higher than 5×10^{-4} Torr during a TUNE procedure. 	<p>The system has switched off the filament, waited ten seconds and turned the filament back on. If this condition persists, the User should cancel the testing procedure. If the unit is already in the Standby mode, no testing is allowed.</p>	<ol style="list-style-type: none"> 1) High-vacuum pressure burst is too powerful. 2) Vacuum system leak. 3) Defective circuit board B. 	<ol style="list-style-type: none"> 1) Lower the Crossover 2 set point and increase the Fine Crossover Delay (D1) and or the Direct Rough Close Delay (D2). 2) Isolate and repair the leaking valve or O-ring. 3) Replace circuit board B.
<p>ERROR 04: Auto Zero Error</p> <p>The Leak the User has attempted to "Auto zero" is too large for the systems Auto Zero function to handle.</p>	<p>The Auto Zero function will not be enabled. This error is not self clearing. To clear the error and start another test cycle, place the unit in Standby Mode and press the ZEOR momentary switch again.</p>	<p>The test object has a leak that is too large for the current test mode.</p>	<ol style="list-style-type: none"> 1) Change the test mode. 2) Allow the unit to pump away excess helium (while in Standby mode).
<p>ERROR 05: Foreline Test Error</p> <p>The foreline region pressure has exceeded 7,000 milliTorr.</p>	<p>With the exception of the foreline valve, all vacuum system valves that are open will be closed. The unit places itself in Standby mode.</p>	<ol style="list-style-type: none"> 1) Crossover 1 set point has been set at too high a level. 2) Vacuum system leak. 	<ol style="list-style-type: none"> 1) Lower the Crossover 1 set point and increase the Reverse Rough Close Delay (D7). 2) Isolate and repair the leaking valve or O-ring.
<p>ERROR 07: High Voltage Error</p> <p>One or more of the high-voltage supplies on Circuit Board B has/have failed.</p>	<p>The system will shut off the filament, shut all valves and turn off all pumps.</p>	<ol style="list-style-type: none"> 1) Short in the Mass Spectrometer source (usually have Error 10 at the same time). 2) Malfunctioning Circuit Board B. 3) Malfunctioning power supply. 	<ol style="list-style-type: none"> 1) Clean the Mass Spectrometer source. 2) Replace Circuit Board B. 3) The power supply should be replaced. Contact the Customer Service Department at Vacuum Instrument Corporation.
<p>ERROR 08: Low Filament Error</p> <p>Filament current has dropped below 1 Ampere.</p>	<p>System will keep working; the error will still be displayed on the User Panel.</p>	<p>The useful life of the filament has expired or the filament is defective.</p>	<ol style="list-style-type: none"> 1) Change to other filament (using the Filament 1/2 momentary switch on the Service Panel). 2) Replace the filament.
<p>ERROR 09: High Temperature Error</p> <p>Temperature within the unit is too high for the leak detector to function accurately (the temperature sensor reading is $>60^{\circ}\text{C}$).</p>	<p>After a twenty second delay, the unit will again measure the temperature. If the temperature is still too high, the unit will measure the temperature ten successive times to see if the temperature is within an acceptable range. If the temperature is still too high the unit will shut down.</p>	<ol style="list-style-type: none"> 1) Ambient temperature may be too high for the unit to function. 2) Internal Fan may have failed. 3) Temperature sensor defective. 	<ol style="list-style-type: none"> 1) The unit must be placed in an area with a lower ambient temperature. 2) Replace the internal fan. 3) Replace temperature sensor.
<p>ERROR 10: Emission Error</p> <p>The filament current is below its allowable limit (4.7 mA).</p>	<p>During testing, the system will display the error on the User Panel. If the unit is performing a Tune or Calibration Check sequence, the system will abort the procedure. The User cannot perform a Calibration Check sequence after this error has occurred.</p>	<ol style="list-style-type: none"> 1) Unit is improperly tuned. 2) The filament is not properly aligned within the Source. 3) Short in the Mass Spectrometer Source (usually accompanied by Error 07). 	<ol style="list-style-type: none"> 1) Perform the TUNE sequence. 2) Re-align or replace the filament. 3) Clean the Mass Spectrometer Source.

MS-60 MANUAL - ADVANCED LEAK METROLOGY DIVISION

Error Code/Explanation	System Response	Probable Cause	Corrective Action
<p>ERROR 11: PC Remote Error</p> <p>Optional remote computer error.</p>	<p>The system is still usable; however, the remote computer is probable inoperative. This error is not self clearing. To clear the error and resume testing, place the unit in Standby Mode and press the ZERO momentary switch.</p>	<ol style="list-style-type: none"> 1) Improper connection between the leak detector and the remote. 2) Defective cable. 3) Defective remote PC. 	<ol style="list-style-type: none"> 1) Re-connect cable between the leak detector and the remote computer. 2) Replace cable. 3) Repair/replace remote PC.
<p>ERROR 13: Rough Time Error</p> <p>Test port pressure cannot be pumped to crossover pressure within the allotted time (5 minutes). This error will only occur when the unit is performing a Calibration Check or during the Tune procedure.</p>	<p>The system will abort the Calibration Check or the Tune procedure. This error is not self clearing. To clear the error and to resume testing, place the unit in Standby Mode and press the ZERO momentary switch.</p>	<ol style="list-style-type: none"> 1) Object attached to the test port is not secure. 2) Contaminated oil in the rough pump. 3) Miscalibrated test port Pirani. 4) Defective test port Pirani. 	<ol style="list-style-type: none"> 1) Reattach the Test Object to the Test Port. 2) Change the Oil in the rough Pump 3) Recalibrate the Test Port Pirani. 4) Replace the Test Port Pirani.
<p>ERROR 18: Printer Error</p> <p>Optional printer is not responding.</p>	<p>The system will display the error. All other functions will continue. This error is not self clearing. To clear the error, place the unit in Standby mode and press the Zero momentary switch.</p>	<ol style="list-style-type: none"> 1) Printer not switched on. 2) No paper in printer. 3) Defective cable between the unit and the printer. 4) Cable not securely attached to the printer or to the leak detector. 5) Defective printer. 	<ol style="list-style-type: none"> 1) Switch printer on. 2) Add paper to printer. 3) Replace printer cable. 4) Reattach printer cable. 5) Repair or replace printer.
<p>ERROR 20: Gain Too Low Error</p> <p>At end of a Tune or Calibration cycle, one of the system gains (either G2 or G3) has been set below the allowable limits.</p>	<p>The system will display the error on the user panel. Testing will not be allowed. This error is not self clearing and may only be cleared by performing a successful Tune or Cal Check/Cal sequence.</p>	<ol style="list-style-type: none"> 1) The value of the internal calibrator has been programmed incorrectly. 2) The Tune cycle was interrupted, or there is a problem with the selected filament. 	<ol style="list-style-type: none"> 1) Reprogram the internal calibrator leak rate and temperature to the values stamped on the calibrator. 2) Switch to the other filament and re-tune the unit.
<p>ERROR 22: Temperature Low Error</p> <p>The temperature sensor indicates a reading below 10°C.</p>	<p>After a twenty second delay, the unit will again measure the temperature. If the temperature is still too low, the unit will measure the temperature ten successive times to see if the temperature is within an acceptable range. If the temperature is still too low the unit will shut down.</p>	<ol style="list-style-type: none"> 1) Ambient temperature is too low for the unit to function properly. 2) Defective temperature sensor. 3) Defective circuit board A. 	<ol style="list-style-type: none"> 1) The unit must be placed in an area with higher ambient temperature. 2) Replace sensor. 3) Replace circuit board A.
<p>ERROR 23: Can't Peak Error</p> <p>During a Tune cycle, while the unit scans the voltages emitted by the source, the unit cannot identify a leak rate peak (indicating helium).</p>	<p>System aborts the Tune cycle. In order to resume testing or to attempt to re-tune the unit, place the unit in Standby Mode and press the ZERO momentary switch.</p>	<ol style="list-style-type: none"> 1) Filament was shut off or switched during tuning. 2) Filament failed during the Tune cycle. 3) Magnets attached to Mass Spectrometer housing are improperly aligned. 4) Contaminated Source. 	<ol style="list-style-type: none"> 1) Verify that the desired filament is selected and on, and reattempt the Tune cycle. 2) Switch to the other filament, verify that it is working (green LED) and reattempt Tune cycle. 3) Realign or replace the magnets attached to the spectrometer housing. 4) Clean the Source
<p>ERROR 24: High Gain Error</p> <p>At the end of a Tune cycle or a Calibration function, the unit cannot supply a "gain" (G2 or G3) within system limits (maximum 10.0)</p>	<p>The system will display the error on the User Panel. This error is not self-clearing. The error may only be cleared by performing a successful Tune or Cal Check/cal sequence.</p>	<ol style="list-style-type: none"> 1) Tune cycle was interrupted. 2) The internal calibrator leak rate has been programmed incorrectly. 3) Filament emission is unstable or below five milliamps. 4) Mass Spectrometer has become significantly contaminated. 5) Internal calibrator has failed. 	<ol style="list-style-type: none"> 1) Perform another Tune or Calibration Check procedure. 2) Reprogram the calibrator leak rate and temperature to the values stamped on the calibrator. 3) Check that the filament emission is stable and at approximately 5 milliamps (by using the Emission function on the Service Panel). If the emission is not stable replace the filament. 4) Clean the Mass Spectrometer housing, then retune. 5) Replace the internal leak standard.
<p>ERROR 26: Turbo Fail Error</p> <p>The system has detected an error with the turbomolecular pump system.</p>	<p>The system has shut off the filament, rough pumps, and turbomolecular pump and has closed all valves.</p>	<ol style="list-style-type: none"> 1) Defective "A" circuit board. 2) Turbomolecular pump electronic controller has failed. 3) Turbomolecular pump has failed. 	<ol style="list-style-type: none"> 1) Replace the "A" circuit board. 2) Replace the turbomolecular pump controller. 3) Replace the turbomolecular pump.

Error Code/Explanation	System Response	Probable Cause	Corrective Action
<p>ERROR 30: Handheld Remote Error</p> <p>Transmission error between the handheld remote and the main unit.</p>	<p>The handheld remote functions are inoperative. This error is not self-clearing. To clear the error and resume the test cycle, place the unit in Standby Mode and press the ZERO momentary switch.</p>	<ol style="list-style-type: none"> 1) Plug for cable is not properly connected. 2) Handheld remote cable is defective. 3) Defective remote. 	<ol style="list-style-type: none"> 1) Ensure that the connection between the cable and the unit is secure. 2) Replace the cable. 3) Replace the remote.
<p>ERROR 33: Repeller Fail Error</p> <p>There is a discontinuity in the circuitry for the Mass Spectrometer Source repeller.</p>	<p>The system will continue to operate, but testing will not be allowed.</p>	<ol style="list-style-type: none"> 1) The Source repeller is broken or contaminated. 2) The circuit board card B is defective. 	<ol style="list-style-type: none"> 1) Rebuild or replace the Source. 2) Replace circuit board B.

CHAPTER FIVE - Parts List

5.1 INTRODUCTION

This chapter contains a listing of recommended spare parts for the MS-60 (Section 5.2) plus a detailed listing of system components (Section 5.3).

5.2 RECOMMENDED SPARE PARTS FOR THE MS-60

DESCRIPTION	PART NUMBER
MASS SPECTROMETER	0137-010-00
SOURCE ASSEMBLY	0137-014-00
SOURCE REBUILD KIT	0126-186-00
COLLECTOR ASSEMBLY	0136-051-00
FILAMENT KIT	0103-141-01
INTERNAL ROUGH PUMP - 7 CFM 110/120 V, 50/60 HZ	312-191-1045
TURBOMOLECULAR PUMP	353-691-1017
PIRANI GAUGE	341-091-2014
A BOARD	584-802
B BOARD	584-803
C BOARD	584-810
CONNECTOR PANEL BOARD	584-805
POWER DISTRIBUTION BOARD	584-807
LED/MEMBRANE BOARD	584-806
ACCESSORY KIT	0142-800-00

5.3 BILL OF MATERIAL

BILL OF MATERIAL
MS60 SHIPPING ASSEMBLY VIC# 014290001
(10.6CFM, 230VAC)

DWG # 014290001 - MS60 SHIPASSY,10.6CFM, 230VAC 50/60HZ				
REF.#	DESCRIPTION	PART #	QTY.	UNIT
10	MS60 FINAL ASSY,10.6CFM,120VAC 50/60HZ	014200001	1	EA
20	ACCESSORY KIT	014280000	1	EA
30	MANUAL	110919700	1	EA
DWG # 014200000 - MS60 FINAL ASSY,10.6CFM,230VAC 50/60HZ				
REF.#	DESCRIPTION	PART #	QTY.	UNIT
10	COMMON PARTS	014250000	1	EA
20	MS60 VOLTAGE KIT, 230V 50/60HZ	014250701	1	EA
30	MS60 TEST PROCEDURE	014260000	1	EA
40	MS60 ROUGH MODULE,230/240VAC INCLUDES BLOCK AND VALVE	014250101	1	EA
50	PUMP/FILTER ASSY 10.6 CFM 240V SET MOTOR FOR 240VAC (861-203)	014230001	1	EA
60	PUMP PLATE ASSY	655-120	1	EA
70	DRAIN COCK ASSY	655-122	1	EA
80	PUMP PURGE ASSY	655-127	1	EA
DWG # 014280000 - ACCESSORY KIT, MS60				
REF.#	DESCRIPTION	PART #	QTY.	UNIT
1	FILAMENT KIT,LANTHANUM/YTTRIUM COATED IRIIDIUM BOX 5-PER	010314108	1	EA
2	OIL, INLAND 45 VACUUM PUMP LUBRICATING	760-54-001	1	EA
3	FUNNEL - 1/2PT. 3-5/8 X 4-5/16 TIN	133012900	1	EA
4	ALLEN WRENCH 7/64	133039100	1	EA
5	CONN, PLUG, 4-POS, 3.81 PITCH	282-111-2004	1	EA
6	CONN, PLUG, 6-POS, 3.81 PITCH	282-111-2006	1	EA
7	CONN, PLUG, 10-POS, 3.81 PITCH	282-111-2010	2	EA
8	QC ADAPTOR ASSY, VF25 TO 1 1/8	162122705	1	EA
9	QUICK COUPLING PLUG	012628400	1	EA
DWG # 014250000 - COMMON PARTS, MS60				
REF.#	DESCRIPTION	PART #	QTY.	UNIT
1	VALVE BLOCK ASSY	014202000	1	EA
2	CHASSIS ASSY	014252200	1	EA
3	MS60 ELECTRICAL ASSY	014252300	1	EA
4	MANIFOLD, TURBO PUMP	013720600	1	EA
5	O RING F150-258	001111500	2	EA
6	O RING, 15/16 ID X 3/32W, BUNA	001111900	1	EA
7	PUMP, TURBO, EXT75DX, IS063	353-691-1017	1	EA
8	MASS SPEC ASSY	013701000	1	EA
9	CALIBRATOR SUB-ASSEMBLY	013701600	1	EA

MS-60 MANUAL - ADVANCED LEAK METROLOGY DIVISION

DWG # 014250000 - COMMON PARTS, MS60

REF.#	DESCRIPTION	PART #	QTY.	UNIT
10	TEMP SENSOR ASSY	831522600	1	EA
11	CENTERING RING ASSY, BUNA-N	162123112	2	EA
12	CLAMP, NW-10/16, LOW-CLEARANCE	442-094-2036	2	EA
13	VACUUM MANIFOLD	013721400	1	EA
14	HEATSINK MODIFICATION	013723200	1	EA
15	SOURCE SUPPORT BRACKET	013723600	1	EA
16	CLAMP, DBL. CLAW MF-63/80/100	133152700	4	EA
17	GAUGE PIRANI .500 DIA	341-091-2014	2	EA
18	BACKING RING, PIRANI	424-691-1064	2	EA
19	NUT, PIRANI	424-691-1065	2	EA
20	O RING, BUNA-N, #2-112	492-092-2112	2	EA
21	HOSE, FLEX, S/S, VF25, 12" LG	162121703	1	EA
22	CLAMP, VF20/VF25	162123903	3	EA
23	SEAL RING, NW-25	441-091-2006	3	EA

DWG # 014202000 - VALVE BLOCK ASSY, MS60

REF.#	DESCRIPTION	PART #	QTY.	UNIT
1	VALVE BLOCK, UPPER	013720000	1	EA
2	VALVE BLOCK LOWER	412-003-0002	1	EA
3	COVER, VALVE BLOCK	013720200	1	EA
4	O RING F150-258	001111500	1	EA
5	O RING 2 7/8 X 1/8, BUNA 233N70	001123300	1	EA
8	GROSS VALVESEAT/RESTRICTOR ASSY	0137-403-00	1	EA
9	O RING 7/16X1/16W	001601300	1	EA
10	O RING, 7/64 ID X 1/16 W, BUNA/NITRILE	001800700	1	EA
11	VALVE OPERATOR TYPE#6011 24VDC	189028900	2	EA
12	FILTER, 1/8NPT SILENCER	189015400	1	EA
13	MALE ELBOW,1/8MPT-1/4TUBE	162072600	1	EA
14	PIPE PLUG 1/4 NPT BRASS	162065500	1	EA
20	VALVE OPERATOR TYPE#6014 24VDC	189028920	1	EA
21	CALIBRATOR VALVE BLOCK	013721200	1	EA
22	QUICK COUPLING INSERT	162133800	1	EA
23	ELBOW, 1/8 FPT THRU, BRASS	162133900	1	EA
24	O-RING, 7/16ID X 1/16W VITON	001201300	1	EA
28	VALVE OPERATOR 24VDC	189028400	2	EA
29	VALVE MODIFICATION DRAWING	013772500	0	EA
30	PLUNGER, VALVE OPERATOR	189003600	1	EA
31	SCREW, PAN HD, M3 X .5, 45 MM	133177600	2	EA
32	ELBOW,MALE 1/4MPT - 1/4TUBE	162072700	1	EA
33	VALVE OPER.#211, 24VDC	189028500	1	EA

MS-60 MANUAL - ADVANCED LEAK METROLOGY DIVISION

DWG # 014252200 - CHASSIS ASSY MS60				
REF.#	DESCRIPTION	PART #	QTY.	UNIT
1	BEZEL ASSY	655-118	1	EA
2	FRONT DOOR ASSY	655-119	1	EA
4	SNIFFER PANEL ASSY	655-121	1	EA
5	BASEPLATE	462-021-0014	1	EA
6	SIDE PANEL RIGHT, ASSY	465-021-0013	1	EA
7	SIDE PANEL,LEFT ASSY	465-021-0015	1	EA
8	TOP COVER SILK SCREEN	465-021-0018	1	EA
9	HINGE BRACKET	462-021-0018	1	EA
10	KEYBOARD SUPPORT ASSY	462-021-0015	1	EA
11	LATCH BRACKET	464-021-0021	2	EA
12	NUT PLATE (LATCH BKT)	464-021-0022	2	EA
13	SHIPPING BRACKET	464-021-0023	1	EA
14	CONNECTOR PANEL,SCREENED	464-021-0027	1	EA
15	BRACKET,FAN	464-021-0006	1	EA
16	AIR FILTER-PUMP .34 X 4.78 X 9.0	433-091-1073	1	EA
17	AIR FILTER-INTAKE .34X3.63X7.75	433-091-1074	1	EA
18	BRACKET (POWER DIST)	464-021-0024	1	EA
19	FRAME CENTER	462-021-0010	1	EA
20	HANDLE, FOLDING 3/8DIA X 9" LG SS	488-091-0002	2	EA
21	RECEPTACLE, VIBRATION ISOLATION	800346	2	EA
22	FOOT,DELRIN 1.00 DIA X 1.00 HT	78002007	4	EA
23	BRACKET,ANGLE	464-021-0026	1	EA
24	LABEL, MS60 VALVE SCHEMATIC	487-094-0015	1	EA
25	LOGO "MS60" (FRONT DOOR)	487-094-0016	1	EA
DWG # 014252300 - MS60 ELECTRICAL ASSY				
REF.#	DESCRIPTION	PART #	QTY.	UNIT
10	PC BOARD ASSEMBLY, "A" BD	584-802	1	EA
20	PC BOARD ASSEMBLY, B-BOARD	584-803	1	EA
30	PC BOARD ASSY, "C" BOARD	584-810	1	EA
40	PC BOARD ASSY, CONNECTOR PANEL	584-805	1	EA
50	PC BOARD ASSY, PWR DISTRIBUTIN	584-807	1	EA
60	CABLE PACKAGE	936-165	1	EA
70	SPEAKER 8 OHM	900159	1	EA
80	POWER SUPPLY,24V,200W	246-231-0009	1	EA
90	PC BOARD ASSY, LED/MEMBRANE BD	584-806	1	EA

MS-60 MANUAL - ADVANCED LEAK METROLOGY DIVISION

DWG # 936-165 - CABLE PACKAGE MS60				
REF.#	DESCRIPTION	PART #	QTY.	UNIT
10	CABLE ASSY, MAIN PWR & SWITCH	872-600	1	EA
20	CABLE ASSY, POWER SUPPLY	872-601	1	EA
30	CABLE ASSY, SYSTEM PUMP	872-602	1	EA
40	CABLE ASSY, TURBO COMMAND	872-603	1	EA
50	CABLE ASSY, "A" BOARD POWER	872-604	1	EA
60	CABLE ASSY, "B" BOARD POWER	872-605	1	EA
70	CABLE ASSY, AC VALVE CONTROL	872-606	1	EA
80	CABLE ASSY, ROUGH VALVES (AC)	872-607	1	EA
90	CABLE ASSY, COLLECTOR	872-608	1	EA
100	CABLE ASSY, SOURCE	872-609	1	EA
110	CABLE ASSY, TEMP, TPP & FLP	872-610	1	EA
120	CABLE ASSY, VALVES	872-611	1	EA
130	CABLE ASSY, RS485 (A-C BOARD)	872-612	1	EA
140	CABLE ASSY, RS485 (A-B BOARDS)	872-613	1	EA
150	RIBBON ASSY, CONNECTOR BOARD	872-614	1	EA
160	CABLE ASSY, AUDIO	872-615	1	EA
170	CABLE ASSY, FAN (SPECTUBE)	872-616	1	EA
190	CABLE ASSY, FAN (SIDE WALL)	872-618	2	EA
DWG # 013701000 - MASS SPEC ASSY				
REF.#	DESCRIPTION	PART #	QTY.	UNIT
2	SOURCE BODY	013701100	1	EA
4	COLLECTOR BODY WELDMENT	013605300	1	EA
6	SLIT PLATE CENTER	013019500	1	EA
8	SOURCE ASSY	013701400	1	EA
10	COLLECTOR ASSY	013605100	1	EA
12	MAGNET ASSEMBLY	013015103	2	EA
13	SCREW SOC HD CAP 4-40 X 3/8LG S.STL 316	489-091-0062	4	EA
14	SCREW, 2-56 X 3/16 VENTED, S/S	013016800	2	EA
16	O RING 2 1/2 IDX1/16 W	001103700	2	EA
18	O RING 1 1/8 X 1/16	001102400	1	EA
DWG # 013701400 - SOURCE ASSY				
REF.#	DESCRIPTION	PART #	QTY.	UNIT
2	ION ACCELERATING PLATE ASS'Y WITH EYELET	013722800	1	EA
4	SPACER	010312400	16	EA
6	SPACER	010312500	4	EA
8	INSULATOR, CERAMIC, 1.350 LG	013712600	4	EA
10	FIL KIT BOX OF 5 ONE BOX HAS 5 FIL'S	010314101	0	BX
12	FIL BLOCK F100-436	010314500	2	EA
14	BLOCK, CLAMPING	010314600	1	EA
16	FILAMENT MTG. STUD	010314700	4	EA
18	SHIELD ASSEMBLY	012005500	1	EA
20	ELECTRON FOCUS PLATE ASSEMBLY	012005700	1	EA

MS-60 MANUAL - ADVANCED LEAK METROLOGY DIVISION

DWG # 013701400 - SOURCE ASSY

REF.#	DESCRIPTION	PART #	QTY.	UNIT
22	REPELLER GRID ASSEMBLY	012028400	1	EA
24	SOURCE FLANGE ASSY	013506600	1	EA
26	STUD, THREADED	013507700	4	EA
28	ION FOCUS PLT STAMPING	050117500	2	EA
30	EYELET, CONTACT	133005900	6	EA
32	EYELET FLAT FLANGE BR	133009500	12	EA
34	STANDOFF S/S 37/64	800317	0	EA
36	SOLID COPPER WIRE 18	111013400	0	FT
38	MS60 SOURCE TEST PROCEDURE	013560900	0	EA
40	SCREW, 2-56 X 3/16 VENTED, S/S	013016800	0	EA

DWG # 013605100 - COLLECTOR ASSY

REF.#	DESCRIPTION	PART #	QTY.	UNIT
2	INSULATOR	010312300	2	EA
4	SPACER	010312400	6	EA
6	GROUND PLATE	010317500	1	EA
8	GROUND LUG	010317600	1	EA
10	SUPPRESSOR LUG	010317900	1	EA
12	SLIT PLATE, COLLECTOR	010318100	1	EA
14	TARGET PLATE & STEM ASSEMBLY	010320500	1	EA
16	SUPPRESSOR PLATE	012620300	1	EA
18	GROUND PLATE TUBE	013039500	1	EA
20	INSULATOR	013039600	1	EA
22	COLLECTOR FLG ASSY	013606800	1	EA
24	BRACKET, RELAY, COLLECTOR	013507400	1	EA
26	TARGET SUPPORT RING ASSEMBLY	013507600	1	EA
28	STUD, THREADED	013507700	2	EA
30	RESISTOR, FA-150 IT +/-5%	172092401	1	EA
32	HEAT SINK	800004	1	EA
34	STANDOFF S/S 1 5/32	800318	2	EA
36	RIVET TUB S/S	800320	1	EA
38	TO-5 RELAY	849069	1	EA
40	FUSE CLIP W/LUG	869322	1	EA
42	OP AMP	953420	1	EA
44	CAPACITOR, 10UF 25V TB10/25K1	981610125	2	EA
46	CAPACITOR, CERAMIC, .01MF 100V	9863101	2	EA
48	CAPACITOR, CERAMIC .22 UF 50 V	98642250	1	EA
50	RESISTOR, FILM 681K 1/8 W 1%	9914681	1	EA
52	MOX-300-1000MEG, 1%	9941040	1	EA
54	RES COMP 1M 1/4W	999510	1	EA
56	LABEL, STATIC WARNING	146065200	1	EA
57	TRANSZORB, 15V	12153001	1	EA

MS-60 MANUAL - ADVANCED LEAK METROLOGY DIVISION

DWG # 013701600 - CALIBRATOR SUB-ASSEMBLY

REF.#	DESCRIPTION	PART #	QTY.	UNIT
1	CAP	613001301	1	EA
2	CERTIFICATE OF CALIBRATION	700003200	0	EA
3	QUICK COUPLING BODY	162133700	1	EA
4	LABEL, CAL.	830058005	0	EA
5	BODY WELDMENT	613002500	1	EA

DWG # 831522600 - TEMP SENSOR ASSY

REF.#	DESCRIPTION	PART #	QTY.	UNIT
1	WIRE, 2 COND/SHLD, 24GA	RJB24001	1	FT
2	CONN, 3PIN MALE MATE-N-LOK	889500	1	EA
3	PIN MATE-N-LOK 24/18	889515	3	EA
4	PC BOARD ASSEMBLY, TEMPSENSE	584-820	1	EA
5	SOLDER SLEEVE	900229	1	EA
6	SLEEVING, SHRINK, .093 ID/.046	VNS00904	0	FT
7	WIRE, 22GA, BRN	013-122-3002	0	FT
8	LABEL, TEMP.	830058002	1	EA

DWG # 013721400 - VACUUM MANIFOLD

REF.#	DESCRIPTION	PART #	QTY.	UNIT
1	MODIFIED NW63 FLANGE	013728800	1	EA
2	HIGH VACUUM FLANGE	013729100	1	EA
3	EXTENSION TUBE 3/4 DIA X 1.42	013729000	1	EA
4	MODIFIED KF16 STUB	013728900	1	EA
5	ELBOW, 3/4" 90 DEGREE	429-092-4063	1	EA
6	SUPPORT GUSSET	013729200	1	EA

DWG # 014250701 - MS60 VOLTAGE KIT, 230/240V 50/60HZ

REF.#	DESCRIPTION	PART #	QTY.	UNIT
10	LINE CORD, UK PLUG	869395	1	EA
20	CONNECTOR, AC RECEPT, MALE	246-111-0003	1	EA
30	BREAKER, ROCKER, 20AMP DP	366-244-0020	1	EA
40	VALVE MODIFIED, 240V	013712001	1	EA

DWG # 014250101 - MS60 ROUGH MODULE, 230-240VAC INCLUDES BLOCK AND VALVE

REF.#	DESCRIPTION	PART #	QTY.	UNIT
1	MANIFOLD, TEST PORT	013720300	1	EA
2	MANIFOLD ROUGH VALVE	412-003-0001	1	EA
3	ADAPTER PLATE, MANIFOLD	412-003-0003	1	EA
4	O-RING, #2-120 80 DUROMETER	492-092-2120	1	EA
5	O-RING, BUNA-N, # 2-119	492-092-2119	1	EA
6	ROUGHING LINE ASSEMBLY	652-159	1	EA
7	VALVE SOLENOID 230VAC, W VALVE BODY	473-791-0421	1	EA
8	O RING, BUNA-N, #2-122	492-092-2122	1	EA

MS-60 MANUAL - ADVANCED LEAK METROLOGY DIVISION

DWG # 014250101 - MS60 ROUGH MODULE,230-240VAC INCLUDES BLOCK AND VALVE				
REF.#	DESCRIPTION	PART #	QTY.	UNIT
9	O RING, BUNA-N, IND.#2-115	492-092-2115	1	EA
10	CENTERING RING ASSY, BUNA-N, V	162123113	1	EA
11	CLAMP, VF20/VF25	162123903	1	EA
12	FLANGE, BLANK, VF25	162120503	1	EA
DWG # 652-159 - ROUGHING LINE ASSEMBLY MS60				
REF.#	DESCRIPTION	PART #	QTY.	UNIT
1	FLANGE UPPER-ROUGH LINE	424-691-1063	1	EA
2	FLANGE LOWER-ROUGH LINE	424-691-1060	1	EA
3	TUBE VERTICAL - ROUGH LINE	424-691-1061	1	EA
4	TUBE HORIZONTAL- ROUGH LINE	424-691-1062	1	EA
5	BELLOWS, WELD IN (.750 DIA TUBING)	424-691-0017	1	EA
6	ELBOW 90 X 3/4 ST STL	429-092-4033	1	EA
7	FLANGE, NW-25, SHORT STUB	442-094-2014	1	EA
DWG # 014230001 - PUMP/FILTER ASSY 10.6 CFM 240V SET MOTOR FOR 240VAC (861-203)				
REF.#	DESCRIPTION	PART #	QTY.	UNIT
1	PUMP 10.6 CFM 115/230 1 PHASE	312-191-1073	1	EA
2	OIL, INLAND 45 VACUUM PUMP LUBRICATING	760-54-001	1	EA
3	FILTER ASSY EXHAUST	655-126	1	EA
4	WORK PROCEDURE, VOLTAGE RANGE CHANGE	861-203	1	EA
DWG # 655-126 - FILTER ASSY EXHAUST MS60				
REF.#	DESCRIPTION	PART #	QTY.	UNIT
1	FILTER EXHAUST W/901-915 ELEM- ENT 10 CFM	425-691-2139	1	EA
2	SEAL RING, NW-25	441-091-2006	1	EA
3	CLAMP, NW-25	442-094-2012	1	EA
4	TYGON TUBING	175006300	2	FT
DWG # 655-120 - PUMP PLATE ASSY MS60				
REF.#	DESCRIPTION	PART #	QTY.	UNIT
1	PLATE, PUMP RECEIVER	464-021-0009	1	EA
2	VIBRATION ISOLATOR M/F 1/4-20 X 1	127018000	4	EA
3	PUMP GUIDE	464-021-0007	2	EA
4	PLATE, PUMP MOUNTING	464-021-0008	1	EA
DWG # 655-122 - DRAIN COCK ASSY MS60				
REF.#	DESCRIPTION	PART #	QTY.	UNIT
1	VALVE DRAIN COCK 1/8-NPT BRASS	189035701	1	EA
2	ADAPTER, HOSE DRAIN COCK	442-093-1059	1	EA
3	ADAPTER, OIL DRAIN VALVE	442-093-1058	1	EA
4	O RING F25-400 VITON	001211500	1	EA

MS-60 MANUAL - ADVANCED LEAK METROLOGY DIVISION

DWG # 655-127 - PUMP PURGE ASSY MS60

REF.#	DESCRIPTION	PART #	QTY.	UNIT
1	ANGLE, VALVE MTG	464-021-0020	1	EA
2	VALVE SOLENOID 2 WAY 1/8-NPT 24VDC	372-692-1061	1	EA
3	TEE, MALE RUN, SWIVEL, 1/4 TUBE X 1/8 NPT	485-093-2037	1	EA
4	ELBOW, MALE SWIVEL, 1/4 TUBE X 1/8 NPT	485-093-2038	1	EA
5	BLOCK, PUMP BALLAST	013644600	1	EA
6	FITTING, F ELBOW 1/4T X 1/4NPT	162160700	1	EA
7	ADAPTER, 1/4 FPT X 1/8 MPT	162074700	1	EA
8	CHECK VALVE	189015500	1	EA
9	TUBING 1/4 OD POLY-FLOLENE	175004600	3	FT

Glossary Of Terms Used In Leak Detection

1. **Background** - In the case of a leak detector, the spurious output, expressed in suitable terms, due to the response to other gases than the actual gas being used for probing. The background may be inherent in the detector, or accidental.
2. **Fine Leak** - A leak that exhibits a leak rate in the range of 10^{-5} to 10^{-11} std cc/sec or lower.
3. **Flooded System** - A system that, while being leak tested under vacuum, becomes so filled with tracer gas as to make impracticable further leak detection by means of a probe.
4. **Gross Leak** - A leak that exhibits a leak rate in the range of 10^{-4} to 1 std cc/sec or higher.
5. **Helium Drift** - In the case of leak detection with a helium probe, the drift of helium to a leak or permeable gasket located at a point sufficiently remote from the end of the probe to mislead the operator into suspecting the area near the probe.
6. **Hood Test** - An overall test in which an object under vacuum test is enclosed by a "hood" which is filled with tracer gas so as to subject all parts of the test object to examination at one time.
7. **Ion Source** - That part of a spectrometer tube in which tracer gas is ionized preliminary to being detected.
8. **Isolation Test** - A method of determining whether a leak is present in a system, or of obtaining an estimate of its magnitude, by observing the rate of rise of pressure in the evacuated system when the system is isolated from the pump. Also called *rate of rise* test.
9. **Leak** - In vacuum technology a hole, or porosity, in the wall of an enclosure capable of passing gas from one side of the wall to the other under action of a pressure or concentration differential existing across the wall.
10. **Leak Detector** - A device for detecting and locating leaks, and indicating the magnitude thereof.
11. **Leak Rate** - In leak detection practice, leak rate is defined as the rate of flow (in pressure-volume units per unit time) through a leak with gas at a specified high pressure (usually atmospheric pressure) on the inlet side and gas at a pressure on the exit side which is low enough to have negligible effect on the rate of flow.
12. **Masking** - The covering of a section of a test object so as to prevent tracer gas from entering leaks that may exist in the covered section.
13. **Mass Spectrometer Leak Detector** - A mass spectrometer adjusted to respond only to a tracer gas. Helium is commonly used as the tracer gas, and thus the instrument is normally referred to as a *helium leak detector*.
14. **Minimum Detectable Leak**
 - a) The size of the smallest leak, expressed in terms of mass flow per unit time that can be unambiguously detected by a leak detector in the presence of noise and background.
 - b) The product of the minimum detectable pressure change and the pumping speed at the detector.
15. **Minimum Detectable Pressure Change** - The pressure producing an indication of three times the noise level.
16. **Noise Level** - In the case of a leak detector, the spurious output, expressed in suitable terms, exhibited by the detector in the absence of an output due to tracer gas.
17. **Pressure Testing** - A leak detecting procedure in which tracer gas is introduced under pressure into the enclosure under examination, and detected as it is emitted from a leak.
18. **Probe** - A tube having a fine opening at one end, used for directing a stream of tracer gas.

- 19. Probe Gas** - A tracer gas which issues from a more-or-less fine orifice so as to impinge on a restricted test area.
- 20. Probe Test** - A leak test in which the tracer gas is applied by means of a probe (see below) so that the area covered by the tracer gas is localized. This enables the individual leaks to be located.
- 21. Sampling Probe** - A device used in pressure testing and so designed as to collect tracer gas from a restricted area of the test object and feed it to the leak detector. Also called *pressure probe* or *sniffer*.
- 22. Soap Bubble Test** - A type of pressure testing in which the tracer gas is detected by bubbles formed in a layer of soap solution applied to the surface of the test object.
- 23. Spectrometer Tube** - The sensing element of a mass spectrometer leak detector.
- 24. Standard Leak**
- a) A device that permits leakage through it, at a specified rate, of a specified gas, with atmospheric pressure at one end of the device and a pressure on the other side sufficiently low to have negligible effect on the leak rate.
 - b) A capillary or porous wall leak, usually in a glass or metal tube, whose dimensions have been adjusted to give a conductance within specified limits for a specified gas at a standard reference temperature with specified inlet and exit pressures. Standard leaks for attaching to vacuum test manifolds with air at atmospheric pressure exposed to the inlet are usually protected by filters to avoid clogging by dust particles. Standard leaks for calibrating mass spectrometers are usually fused to a glass reservoir containing the specified gas at a known high pressure.
 - c) A device providing a known throughput into a vacuum system. Also referred to as a *calibrated leak*.
- 25. Tracer Gas** - A gas that, passing through a leak, can then be detected by a specific leak detector and thus disclose the presence of a leak. Also called *search gas*.
- 26. Vacuum Testing** - A leak detecting procedure, in which the enclosure under examination is evacuated, a tracer gas applied to the outside surface of the enclosure, and the gas detected after entering the enclosure.

A.V.S. Standards

Standards of the American Vacuum Society for the Testing of Mass Spectrometer Leak Detectors

The following paragraphs are extracted, with permission of the American Vacuum Society, from AVS Standards used in defining and testing the operation of mass spectrometer leak detectors. They have been selected because of their application in the testing of all VIC leak detectors. Copies of complete AVS Standard 2.1 ("Calibration of Leak Detectors of the Mass Spectrometer Type") and AVS Standard 2.3 ("Procedure for the Calibration of Gas Analyzers of the Mass Spectrometry Type") are available by writing to Vacuum Instrument Corporation.

© Copyrights 1972, 1973 by the American Vacuum Society

AVS Standard 2.1**3.1 BACKGROUND****3.1.1 General**

In general, background is the total spurious indication given by the leak detector without injected search gas. Background can originate in either the mass spectrometer tube or the associated electric and electronic circuitry, or both. (Frequently, the term is used to refer specifically to the indication due to ions other than those produced from injected search gas).

3.1.2 Drift

The relatively slow change in the background. The significant parameter is the maximum drift measured in a specified period of time.

3.1.3 Noise

The relatively rapid changes in the background. The significant parameter is the noise measured in a specified period of time.

3.1.4 Helium Background

Background due to helium released from the walls of the leak detector or leak detection system.

3.4 LEAKS**3.4.1 Leak (n)**

In vacuum technology a hole, porosity, permeable element, or other structure in the wall of an enclosure capable of passing gas from one side of the wall to the other under action of a pressure or concentration difference existing across the wall.

Also, a device which can be used to introduce gas into an evacuated system.

3.4.1.1 Channel Leak

A leak, which consists of one or more discrete passages that, may be ideally treated as long capillaries.

3.4.1.2 Membrane Leak

A leak which permits gas flow by permeation of the gas through a nonporous wall. For helium, this may be a wall of glass, quartz, or other suitable material.

3.4.1.3 Molecular Leak

A leak through which the mass rate of flow is substantially proportional to the reciprocal of the square root of the molecular weight of the flowing gas.

3.4.1.4 Viscous Leak

A leak through which the mass rate of flow is substantially proportional to the reciprocal of the viscosity of the flowing gas.

3.4.2 Calibrated Leak

A calibrated leak for which the rate of leakage is known under standard conditions, namely, 23 ±3°C, a pressure of 760 Torr ±5% at one end of the leak, and a pressure at the other end so low as to have a negligible effect on the leak rate.

3.4.3 Virtual Leak

The semblance of a leak due to the evolution of a gas or vapor within a system.

3.5 LEAK RATES**3.5.1 Leak Rate**

The mass rate (also called “throughput”; differentiated from volume rate of flow (liters/sec) also called pumping speed), in Torr liters/sec (or Pa m³/sec) at which a specified gas passes through a leak under specific conditions.

3.5.2 Standard Air Leak Rate

The mass rate of flow, through a leak, of atmospheric air of dew point less than -25°C under standard conditions specified as follows: the inlet pressure shall be less than 760 Torr ±5%, the outlet pressure shall be less than 10 Torr and the temperature shall be 23 ±3°C.

3.5.3 Equivalent Standard Air Leak Rate

Short path leaks having standard air leak rates less than 10⁻⁶/10⁻⁷ Torr liters/sec (10⁻⁷/10⁻⁸ Pa m³/sec) are of the molecular type (see Sec 3.4.1.3). Consequently, helium (mol. wt 4) passes through such leaks more rapidly than air (mol. wt 29) and a given flow rate of helium corresponds to a smaller flow rate of air. In this recommendation, helium flow is measured and the “equivalent standard air leak rate” is taken as $(4/29)^{1/2} = 0.37$ times the helium leak rate under standard conditions (see Sec 3.5.2).

3.8 SENSITIVITY TERMS

3.8.1 Sensitivity

The sensitivity of a device is the change in output of the device divided by the change in input that caused the response.

3.8.2 Minimum Detectable Signal

An output signal due to incoming search gas that is equal in magnitude to the sum of the noise and the drift.

3.8.3 Minimum Detectable Leak (or Minimum Detectable Leak Rate)

The smallest leak, as specified by its standard air leak rate, that can be detected unambiguously by a given leak detector. The minimum detectable leak rate depends on a number of factors. One of the purposes of this Standard is to describe practical procedures for determining minimum detectable leak rate, taking into account background, volume rate of flow (pumping speed), and time factor.

3.8.4 Minimum Detectable Concentration Ratio

The smallest concentration ratio of a given search gas in an air mixture that can be detected unambiguously by a given leak detector when the mixture is fed to the detector at such a rate as to raise the pressure in the instrument to some optimum high value. In this Standard, the minimum detectable leak rate is calculated by a somewhat arbitrary procedure from observations of the response of leak detector to a helium-air mixture of known helium concentration ratio.

5 Test Procedure Minimum Detectable Leak

5.1 DRIFT AND NOISE OBSERVATION

5.1.1

The output of the leak detector is connected to the recorder, the leak detector being at its maximum sensitivity setting and the inlet valve closed.

5.1.2

The leak detector backing-off (or zero) control is adjusted so that the recorder reading is approximately 50% of full scale, the filament being on.

5.1.3

The output is recorded for 20 min. or until the output has reached full scale, for positive drift, or zero, for negative drift.

5.1.4

Draw a series of line segments intersecting the curve recorded in Sec. 5.1.3, the lines to be drawn at 1-min. intervals at right angles to the time axis (abscissa) of the chart, and to commence at the point where the procedure of Sec. 5.1.3 is started. The lines so drawn will be called the "1-min lines."

Draw straight-line approximations for each segment of the curve between adjacent 1-min lines.

5.2 DRIFT AND NOISE DETERMINATION

5.2.1

Examine the straight line approximations of Sec. 5.1.4 to determine that 1-min segment of the output curve having the greatest slope. This greatest slope is measured in scale divisions per minute and is called the drift. If the greatest slope is less than the scale divisions corresponding to 2% of full scale of the recorder, the total (absolute) change in output over the 20-min period is determined. The total change is divided by 20 is then called the drift.

5.2.2

For each 1-min segment of the curve, determine the maximum (absolute) deviation of the recorded curve from the straight-line approximation.

5.2.3

The average of these maximum deviations, multiplied by 2, is called the noise (scale divisions).

Note: In determining the noise, neglect any large deviation (spike) which occurs less frequently than once in any 5-min interval.

5.3 MINIMUM DETECTABLE SIGNAL

The minimum detectable signal is taken to be equal to the sum of the absolute values of the drift and of the noise. It should be measured in scale divisions. If the sum is less than the scale divisions corresponding to 2% of full scale, then the scale divisions corresponding to 2% of full scale is called the minimum detectable signal.

5.4 SENSITIVITY DETERMINATION

5.4.1 Arrangement of Apparatus

The leak detector is connected to an auxiliary system. (Frequently, the auxiliary system is included with the leak detector as an integral part thereof).

The system should contain a minimum of rubber or other polymeric surfaces. Preferably, such surfaces should consist only of the exposed surfaces of an O-ring or O-rings. Accordingly, the "Leak Isolation Valve" should preferably be of all-metal construction, but in any case should not act as a significant source of adsorbed or absorbed helium.

5.4.2 Spurious Signal Correction

Note: This determination requires the use of the small calibrated leak. If the calibrated leak has its own integral valve, and the leak and valve are all-metal construction (except perhaps for the membrane in a membrane-type leak), Sec. 5.4.2 may be omitted from the procedure.

5.4.2.1

A metal plug is connected to the leak detector

5.4.2.2

The output is zeroed, with the filament on.

5.4.2.3

The leak isolation valve is opened.

5.4.2.4

The pump valve is opened. (*Note: For its safety, the filament of the mass spectrometer tube may be turned off at this point.*)

5.4.2.5

When the atmospheric air present between the plug and the inlet valve has been evacuated, the pump valve is closed.

5.4.2.6

The inlet valve is opened promptly, but gradually. The pressure in the leak detector is allowed to reach a steady value, showing no observable change in a 1-min period.

5.4.2.7

Turn on filament of mass spectrometer tube if it is not on.

5.4.2.8

When the output has reached a steady value, but in any case not longer than 3 min after Sec. 5.4.2.6. the output reading is noted. If the leak detector has been set at reduced sensitivity, the reading should be converted to equivalent scale divisions for full-sensitivity setting.

5.4.2.9

Close the leak isolation valve as rapidly as feasible.

5.4.2.10

Note the output reading 10 seconds after closing the isolation valve. As in 5.4.2.8., convert the reading if necessary.

5.4.2.11

Subtract the reading noted in 5.4.2.10 from that noted in 5.4.2.8. If the difference is negative, it is to be considered equal to zero. The difference will be called the "spurious-signal correction" and will be applied in Sec. 5.4.3.14.

5.4.2.12

Close the inlet valve.

5.4.2.13

Open the vent valve.

5.4.2.14

Remove only the plug from the inlet line; all connections are to remain in place.

5.4.2.15

Close the vent valve.

5.4.3 SENSITIVITY**5.4.3.1**

Connect the all-metal leak to the leak detector. However, if the procedure of 5.4.2. was necessary, the small calibrated leak is put in place of the plug removed in 5.4.2.14 above, the leak being inserted the same distance into the connection as the plug had been.

5.4.3.2

The output is zeroed with the filament on.

5.4.3.3

The leak isolation valve is opened.

5.4.3.4

The pump valve is opened.

5.4.3.5

Helium at 760 Torr $\pm 5\%$ pressure is applied to the leak. If the leak has its own supply of helium, this step is omitted. (*Note: the filament of the mass spectrometer tube may be turned off before Sec. 5.4.3.6.*)

5.4.3.6

When the atmospheric air present between the calibrated leak and the leak detector has been evacuated, the pump valve is closed.

5.4.3.7

The inlet valve is opened promptly after Sec. 5.4.3.6. The pressure in the leak detector is allowed to reach a steady value, showing no observable change in 1 min.

5.4.3.8

Turn on filament of mass spectrometer tube if it is not on.

5.4.3.9

At this point it may be necessary to change the sensitivity setting. When the output signal has reached a steady value, showing a change in 1 min that is not greater than the drift (as corrected for the sensitivity setting), the output reading in scale divisions is noted. If the leak detector has been set at reduced sensitivity, the reading should be converted to the equivalent scale divisions for full-sensitivity setting.

5.4.3.10

Immediately after the proceeding step, the stopwatch is started and simultaneously the leak isolation valve is closed as rapidly as practical. Alternatively, the recorder chart may be marked to indicate the beginning of the timed period and the leak isolation valve then closed rapidly.

5.4.3.11

The output is observed continuously and the stopwatch is stopped when the reading has decreased to 37% of the reading observed in Sec. 5.4.3.9. The reading of the stopwatch is noted (T sec.). Alternatively, the recorder chart is examined to determine the time T required for the specific decrease in output. T is the response time (Sec. 3.9.2).

Note: Should response time be a function of sensitivity setting, T as observed should be corrected to response time at full sensitivity setting, if any other setting was used.

5.4.3.12

One minute after closing the leak valve (see Sec. 5.4.3.10), the output is read and noted. Correct for sensitivity setting as in 5.4.3.9.

5.4.3.13

The uncorrected signal due to the calibrated leak shall be taken as the difference between the reading noted in 5.4.3.9, and that noted in 5.4.3.12, the required conversion of these readings to equivalent scale divisions at full-sensitivity setting have been made.

5.4.3.14

The corrected signal due to the calibrated leak is taken as the difference between the uncorrected signal, Sec. 5.4.3.13, and the spurious signal correction in 5.4.2.11. The sensitivity is calculated by the formula below and should always be stated together with the response time, T:

Sensitivity, with Response Time, T =

$$\frac{\text{Signal due to Calibrated Leak}}{\text{Standard or Equivalent Standard Air Leak Rate of Calibrated Leak}}$$

The units are scale divisions (on full sensitivity setting) per unit leak rate (Secs. 3.5 and 3.8).

5.5 MINIMUM DETECTABLE LEAK

Referring to Secs. 5.3 and 5.4.3.14, this is calculated from the formula:

Minimum Detectable Leak, with Response Time T =

$$\frac{\text{Minimum Detectable Signal}}{\text{Sensitivity}}$$

The units are those of leak rate.

AVS Standard 2.3**2.3 SCANS**

A scan is usually shown as a trace on a recorder chart, the abscissa is time, mass, voltage, gauss, etc., and the ordinate is assumed proportional to ion current or “output”. It can also be shown as a table of values, an oscilloscope trace, etc. (The term “mass spectrum” is synonymous with scan or mass scan.) In this standard, it will be assumed for sake of simplicity that the scan is a recorder trace (see Sec. 7.4 “Recorder”), and that the recorder displacements are proportional to input currents.

3.11 PEAK WIDTH, W

In a graphical spectrum, the length of the base of a peak, the base being defined by the intersection or tangency of the legs of the peak with a reference base line. The specification of such a reference line is an important function of this standard. In some discussions, the symbol 3m or 3M is used for peak width rather than W. The units of W are atomic mass units; in some cases, a conversion of units may be necessary (see 2.3 and 4.1).

3.16 RESOLUTION**3.16.1 General Definition**

The ability, or a measure of the ability, of a mass spectrometer to separate the peaks produced by ions of different mass/charge ratios.

3.16.2 Absolute Resolution. *(See General Definition above).*

A measure of the ion-separating ability of a mass spectrometer, at a given mass **M**, given by the peak width, **W**, at **M** :

Absolute resolution (at M) = W AMU

3.16.3 Unity Resolution Mass(es).

The mass number(s) at which the absolute resolution is one (AMU) or “unity”.

3.16.4 Resolving Power.

At a given mass **M**, the ratio of M to peak width **W**:

Resolving Power = $\frac{M}{W} = \frac{M}{M}$ (see 3.11)

4 Discussion of Resolution

4.1 MASS SCALE

Some mass spectrometers produce a graphical scan having an abscissa that is not linear in mass number. It then becomes necessary, for the calculation of resolution, to convert the abscissa to a linear mass scale. To do this, it is assumed that, for a *sufficiently small* range of mass numbers, the abscissa *is* actually *linear* in mass number. To convert from the abscissa scale to mass units, the following formula is used:

$$L = \frac{S'}{|M_1 - M_2|} = \frac{S'}{\Delta M'}$$

where:

S' = peak separation in any convenient units (centimeters, volts, cycles per second, etc.)

L = the number of units, of the kind chosen for S, equivalent to 1 mass unit

M₁ = mass of peak at which resolution is to be determined

M₂ = mass of a neighboring peak

= |M₁ - M₂|

Then, if **W'** is the peak width in the same units as those of **S'**,

$$\begin{aligned} \text{Absolute Resolution} &= \frac{W'}{L} \quad (\text{by definition}) \\ &= \Delta M' \times W'/S' \end{aligned}$$

7.4 RECORDER

This standard requires that the output of the gas analyzer being tested be graphically presented by means of chart recorder. The recorder shall be an instrument which traces a continuous line and which has a time constant (63%) not greater than one second. The recorder shall be so buffered that there is no interaction between the recorder and the meter or other output-indicating device of the gas analyzer; i.e., so that the velocity of response of neither generates sufficient electrical signal to affect the indication of the other. If the recorder is connected in parallel with the output indicator, this interaction will become negligible if each has an input resistance 1000 times that of their common voltage source, or if the recorder draws 1/1000 as much current as the indicator.

While some recorders have automatic decade-switching capabilities, it will be assumed that this recorder can cover only a single linear range; it is also assumed that the recorder displacement is proportional to the input current. In those cases where the analyzer has an output meter, controls shall be available which permit adjusting the zero of the recorder to the zero of the meter, and full-scale deflection of the recorder to full-scale deflection of the meter. This is necessary to permit direct correlation of the meter and recorder indications and also to prevent possible injury to one or more of these devices. However, in order to prevent complications in the language of this standard, it will be assumed that the recorder is the only output indicating device, and that controls for adjusting zero indication and for attenuating output indication act directly on the recorder.

Unit Conversion Tables

The following tables are provided for easy conversion of values between commonly used units of pressure and leak rate.

- **Table A:** Pressure Conversion Chart
- **Table B:** Leak Rate Conversion Chart

MS-60 MANUAL - ADVANCED LEAK METROLOGY DIVISION

T a b l e A	P r e s s u r e C o n v e r s i o n C h a r t	M I L L I B	1 . 0 1	6 . 8 9	1 . 3 3	1 . 3 3	1 . 0 x	1 . 3 3	3 . 3 9	3 . 3 8	2 . 4 9	1 . 0 x	1 . 0 x	1	
		B A R	1 . 0 1	6 . 8 9	1 . 3 3	1 . 3 3	1 . 0 x	1 . 3 3	3 . 3 9	3 . 3 8	2 . 4 9	1 . 0 x	1	1	1 . 0 x
		D Y N E / /	1 . 0 1	6 . 8 9	1 . 3 3	1 . 3 3	1 . 0	1 . 3 3	3 . 3 9	3 . 3 8	2 . 4 9	1	1 . 0 x	1	1 . 0 x
		i n H g 2	4 0 7	2 7 1	5 . 3 6	5 . 3 6	4 . 0 2	5 . 3 6	1 . 3 6	1 . 3 6	1	4 . 0 2	4 . 0 2	4 . 0 2	4 . 0 2
		i n H g	3 0 1	2 . 0 4	3 . 9 5	3 . 9 5	2 . 9 6	3 . 9 5	1 . 0 0	1	7 . 3 7	2 . 9 6	2 . 9 6	2 . 9 6	2 . 9 6
		i n H g	2 9 2	2 . 0 4	3 . 9 4	3 . 9 4	2 . 9 5	3 . 9 4	1	9 . 9 7	7 . 3 5	2 . 9 5	2 . 9 5	2 . 9 5	2 . 9 5
		m m H g	7 6 0	5 . 1 7	1 . 0	1 . 0	7 . 5 x	1	2 . 5 4	2 . 5 3	1 . 8 7	7 . 5 x	7 . 5 x	7 . 5 x	7 . 5 x
		P A S C A .	1 . 0 1	6 . 8 9	1 . 3 3	1 . 3 3	1	1 . 3 3	3 . 3 9	3 . 3 8	2 . 4 9	0 . 1	1 . 0 x	1 . 0 x	1 . 0 x
		M I C R O	7 . 6 x	5 . 1 7	1 . 0	1	7 . 5 x	1 . 0 x	2 . 5 4	2 . 5 3	1 . 8 7	7 . 5 x	7 . 5 x	7 . 5 x	7 . 5 x
		T O R R	7 . 6 0	5 . 1 7	1	1 . 0	7 . 5 x	1 . 0 x	2 . 5 4	2 . 5 3	1 . 8 7	7 . 5 0	7 . 5 2	7 . 5 2	7 . 5 x
		P S I	1 4 . 7	1	1 . 9 3	1 . 9 3	1 . 4 5	1 . 9 3	4 . 9 1	4 . 9 0	3 . 6 1	1 . 4 5	1 . 4 5	1 . 4 5	1 . 4 5
		A T M	1	6 . 8 x	1 . 3 2	1 . 3 2	9 . 8 7	1 . 3 2	3 . 3 4	3 . 3 3	2 . 4 6	9 . 8 7	9 . 8 7	9 . 8 7	9 . 8 7

MS-60 MANUAL - ADVANCED LEAK METROLOGY DIVISION

		FROM TO	ATM	PSI	TORR	MICRON	PASCAL	mm Hg (°C)	In Hg (°F)	In Hg (°F)	In H ₂ O (°F)	DYNE / cm ²	BAR	MILLIBAR
--	--	---------	-----	-----	------	--------	--------	------------	------------	------------	--------------------------	------------------------	-----	----------

T a b l e	L e a k R a t e	C o n v e r s i o n	C h a r t	A i r	1 · 2 9	1 · 2 7 5	1 · 2 8	1 · 2 8	1 · 7 0	2 · 9 0	4 · 8 1	8 · 9 9	1			
				A i r	1 · 4 4	1 · 4 2	1 · 4 1 9	1 · 4 2	1 · 8 9	3 · 2 2	5 · 3 5	1	1 · 1	1 · 1	1 · 1	1 · 1
				A i r	2 · 6 9	2 · 6 5	2 · 6 5	2 · 6 5	3 · 5 4	6 · 0 2	1 · 8 7	1 · 0 8	2 · 0 8	3 · 0 5	5 · 0 9	7 · 0 8
				K g	4 · 4 6	4 · 4 0	4 · 4 0	4 · 4 0	5 · 8 7	1	1 · 6 6	3 · 1 0	3 · 4 5	3 · 1 5	3 · 2 9	3 · 5 9
				T o r r	0 · 7 6	7 · 5 0	7 · 5 0	0 · 7 5	1	1 · 7 0	2 · 8 3	5 · 2 9	0 · 5 9	0 · 7 8	0 · 7 8	0 · 7 8
				M b a r	1 · 0 1	1 · 0 0	0 · 0 1	1	1 · 3 3	2 · 2 7	3 · 7 7	7 · 0 5	0 · 7 8	0 · 7 8	0 · 7 8	0 · 7 8
				P a L / /	1 · 0 1 · 3	1 · 0 0	1	1 · 0 0 · 0	1 · 3 3 · 3	2 · 2 7 · x	3 · 7 7	7 · 0 5	7 · 8 4 · 1	7 · 8 4 · 1	7 · 8 4 · 1	7 · 8 4 · 1
				P a M 3	0 · 1 0	1	1 · 0 0	0 · 1 0	0 · 1 3	2 · 2 7	3 · 7 7	7 · 0 5	7 · 8 4	7 · 8 4	7 · 8 4	7 · 8 4
				S t d c	1	9 · 8 7	9 · 8 7	0 · 9 9	1 · 3 2	2 · 2 4	3 · 7 2	6 · 9 6	0 · 7 7	0 · 7 7	0 · 7 7	0 · 7 7
				F R O M T O	S t d c m ³ / s	P a M ³ / s	P a L / s	M b a r L / s	T o r r L / s	K g M o l e s / s	A i r M o l e c u l e s / s	A i r o z / y r	A i r m g / s	A i r m g / s	A i r m g / s	A i r m g / s

Remote Port Specification For VIC MS-60 Series Leak Detectors

(Ninth Revision 1-20-97)

WARNING:**This information should only be used by experienced and knowledgeable personnel!****Full PC Remote Control Specification**

Using the following specification, software can be written to enable a remote computer to completely control the MS-60 Leak Detector. The remote computer can control every function of the leak detector except for service functions. Service Mode cannot be entered by the remote computer.

Pressures, valve status, current state, and other operating parameters can all be monitored over this communications link. All data is transmitted serially and each byte consists of one ASCII character. Each packet of information begins with an ASCII character between the letter 'A' and the letter 'g'. Certain packets contain a fixed number of bytes and some have a dynamically varying length. MS-60 Software revisions 3.8 and later made the fields fixed in length any only used numbers. The description of each packet will clarify this point. Every packet, minus its initial letter, is made up of the ASCII numbers '0' through '9', the period, and the lowercase 'x'. The beginning of each packet dictates the end of the previous packet (unless terminated as discussed below).

'A' - Followed by a '1'.

'1' - indicates that an invalid command was sent by the remote PC. It could mean that the format of the command was incorrect, or an attempt was made to change a parameter to an invalid value.

'B' - Not used in the MS-60 at this time.

'C' - Followed by 4 or 5 characters.

Leak Rate Value measured in atm-cc/sec or mbar-l/sec. The format is such that it matches that of the MS-30 series leak detectors.

(e.g. 2300 = 2.3×10^{-0} atm-cc/sec)

(e.g. 5708 = 5.7×10^{-8} atm-cc/sec)

(e.g. 10010 = $10^{-0} \times 10^{-10}$ atm-cc/sec)

In software revisions 3.8 and later, this field is fixed at 6 characters.

('C' + 5 numbers).

(e.g. 05708 = 5.7×10^{-8} atm-cc/sec)

(e.g. 10010 = 10.0×10^{-10} atm-cc/sec)

In software rev 7.2 and later, the mantissa length is set via Revision Switch 8. Format is either 6 or 7 characters. UP = mantissa single decimal XX.X, DOWN – mantissa two decimal XX.XX

'D' - Followed by 1 to 6 numbers.

Fore-line Pressure measured in Millitorr (from 0 to 760000 millitorr).

(e.g. 100 = 100 millitorr)

(e.g. 760000 = 760000 millitorr)

In software revisions 3.8 and later, this field is fixed at 7 characters.

('D' + 6 numbers).

(e.g. 0f00100 = 100 millitorr) (e.g. 760000 = 760000 millitorr)

'E' - Followed by 1 to 6 numbers.

Test-port Pressure measured in Millitorr (from 0 to 760000 Millitorr).

(e.g. 200 = 200 millitorr)

(e.g. 50000 = 50000 millitorr)

In software revisions 3.8 and later, this field is fixed at 7 characters.

('E' + 6 numbers).

(e.g. 000100 = 100 millitorr)

(e.g. 760000 = 760000 millitorr)

'F' - Followed by 6 characters.

High Vacuum Pressure measured in Torr (from 7.5×10^{-4} to 2.6×10^{-5}).

(e.g. 2.6×10^{-5} = 2.6×10^{-5} Torr)

(e.g. 1.5×10^{-4} = 1.5×10^{-4} Torr)

In software revisions 3.8 and later, this field is fixed at 4 characters.

('F' + 3 numbers).

(e.g. 105 = 1.0×10^{-5} Torr)

(e.g. 384 = 3.8×10^{-4} Torr)

'G' - Followed by 2 numbers.

Filament Current measured in amperes. (e.g. 23 = 2.3 Amps.)

In software revisions 3.8 and later, this field is fixed at 4 characters.

('G' + 3 numbers).

(e.g. 023 = 2.3 Amps.)

'H' - Followed by 6 numbers.

Emission Current (2 numbers) measured in milliamps.

Reject Status ('0', or '1' = Invalid, '2' = Accept, '3' = Reject)

Ready Light ('0' = OFF, '1' = ON)

Testing Light ('0' = OFF, '1' = ON)

Start Light ('0' = OFF, '1' = ON)

(e.g. 230100 = 2.3 mA, Invalid, Ready ON, Testing OFF, Start OFF)

(e.g. 553011 = 5.5 mA, REJECT, Ready OFF, Testing ON, Start ON)

In software revisions 3.8 and later, this field is fixed at 8 characters.

('H' + 7 numbers. First '3' numbers are emission current).

(e.g. **0470100 = 4.7 milliamps, Invalid, Ready ON, Testing OFF, Start OFF**)

'I' - Followed by 1 to 2 numbers.

Present State of the leak detector.

In software revisions 3.8 and later, this field is fixed at 3 characters with states 0 - 9 preceded by a 0 (00 - 09).

(e.g. , 0 - First Power)

1 - Power Up

2 - Power Up

3 - Power Up

{ States 4 - 10 are for Vacuum Mode, Auto-Ranging }

4 - Standby

5 - Standby

6 - Roughing Test Port

7 - Gross Mode Leak Testing

8 - Reverse Mode Leak Testing

9 - Rough Close Delay

10 - Direct Mode Fine Leak Testing

{ States 11 - 17 are for Vacuum Mode, Manual-Ranging }

11 - Standby

12 - Standby

13 - Roughing Test Port

14 - Gross Mode Leak Testing

15 - Reverse Mode Leak Testing

16 - Rough Close Delay

17 - Direct Mode Leak Testing

{ States 18 - 21 are for Sniffer Mode, Auto-Ranging }

18 - Standby

19 - Standby

20 - Roughing Sniffer Probe

21 - Sniffer Mode Leak Testing

{ States 22 - 25 are for Sniffer Mode, Manual-Ranging }

22 - Standby

23 - Standby

24 - Roughing Sniffer Probe

25 - Sniffer Mode Leak Testing

26 — 36 - Automatic Tuning

37 — 42 - Checking Calibration

43 - Service Mode

In software revisions 3.9 and later, the numbers have changed due to the addition of 2 more states. ('I' + 2 numbers).

00 - First Power

01 - Power Up

02 - Power Up

03 - Power Up

{ States 4 - 11 are for Vacuum Mode, Auto-Ranging }

04 - Standby

05 - Standby

06 - Roughing Test Port

07 - Gross Mode Leak Testing

08 - Reverse Rough Close Delay

09 - Reverse Mode Leak Testing

10 - Direct Rough Close Delay

11 - Direct Mode Fine Leak Testing

{ States 12 - 19 are for Vacuum Mode, Manual-Ranging }

12 - Standby

13 - Standby

14 - Roughing Test Port

15 - Gross Mode Leak Testing

16 - Reverse Rough Close Delay

17 - Reverse Mode Leak Testing

18 - Direct Rough Close Delay

19 - Direct Mode Leak Testing

{ States 20 - 23 are for Sniffer Mode, Auto-Ranging }

20 - Standby

21 - Standby

22 - Roughing Sniffer Probe

23 - Sniffer Mode Leak Testing

{ States 24 - 27 are for Sniffer Mode, Manual-Ranging }

24 - Standby

25 - Standby

26 - Roughing Sniffer Probe

27 - Sniffer Mode Leak Testing

28 — 38 - Automatic Tuning

39 — 44 - Checking Calibration

45 - Service Mode

- 'J' - Followed by 4 or 5 characters.
Reject Set Point in atm-cc/sec.
 (e.g. 5708 = 5.7×10^{-8} atm-cc/sec)
 (e.g. 10010 = 10.0×10^{-10} atm-cc/sec)
 In software revisions 3.8 and later, this field is fixed at 5 characters.
 ('J' + 4 numbers).
 (e.g. 2308 = 2.3×10^{-8} atm-cc/sec. A mantissa of 10.-0 will never be sent.)
- 'K' - Followed by 1 to 3 numbers.
Crossover #2 or Direct Flow Crossover in millitorr.
 (e.g. 10 = 10 millitorr)
 (e.g. 100 = 100 millitorr)
 In software revisions 3.8 and later, this field is fixed at 4 characters.
 ('K' + 3 numbers).
 (e.g. 020 = 20 millitorr)
- 'L' - Followed by 14 numbers.
System Status information.

Char#

- 1 — Turbo Pump Status ('0' = OFF, '1' = ON)
- 2 — Filament Status ('0' = OFF, '1' = ON)
- 3 — Vent Valve Status ('0' = CLOSED, '1' = OPEN)
- 4 — Sniff Valve Status ('0' = CLOSED, '1' = OPEN)
- 5 — Gross Valve Status ('0' = CLOSED, '1' = OPEN)
- 6 — Foreline Valve Status ('0' = CLOSED, '1' = OPEN)
- 7 — Fine Valve Status ('0' = CLOSED, '1' = OPEN)
- 8 — Calibrator Valve Status ('0' = CLOSED, '1' = OPEN)
- 9 — Rough Valve Status ('0' = CLOSED, '1' = OPEN)
- 10 — External Rough Valve Status ('0' = CLOSED, '1' = OPEN)
- 11 — Purge Valve Status ('0' = CLOSED, '1' = OPEN)
- 12 — Zero Light Status ('0' = OFF, '1' = ON)
- 13 & 14 — Error Status

- '01' Fore-line Pressure Too High
- '02' High Vacuum Pressure Too High
- '04' Auto Zero Error
- '05' Foreline Pressure Too High To Test
- '07' High Voltage Failure
- '08' Filament Current Too Low
- '09' Temperature Too High
- '10' Emission Current Too Low
- '11' PC Remote Communications Error
- '13' Rough Time Exceeded
- '18' Printer Error
- '22' Temperature Too Low
- '23' Cannot Find Helium Peak

- '24' Gain Too High
- '26' Turbo Pump Failure
- '30' Hand Held Remote Communications Error
- '33' Repeller Heat Failure
- '51' No Errors

(e.g. L11000111000151 = Turbo Pump On, Filament On, Vent Valve Closed, Sniff Valve Closed, Gross Valve Closed, Foreline Valve Open, Fine Valve Open, Calibrator Valve Open, Rough Valve Closed, External Rough Valve Closed, Purge Valve Closed, Auto Zero Light On, No Errors)

'M' - Not used in the MS-60.

'N' - Followed by 4 characters.

Current Calibrator Temperature in Degrees Celsius.

(e.g. 20.2 = 20.2°C)

In software revisions 3.8 and later, this field is fixed at 4 characters.

('N' + 3 numbers).

(e.g. 273 = 27.3 °C)

'O' - Followed by 3 numbers.

Anode Voltage measured in Volts.

(e.g. 265 = 265 Volts)

(e.g. 310 = 310 Volts)

'P' - Followed by 1 to 2 numbers.

For VIC's internal use only!

In software revisions 3.8 and later, this field is fixed at 3 characters.

('P' + 2 numbers).

'Q' - Followed by 1 to 2 numbers.

For VIC's internal use only!

In software revisions 3.8 and later, this field is fixed at 3 characters.

('Q' + 2 numbers).

'R' - Followed by 1 to 2 numbers.

For VIC's internal use only!

In software revisions 3.8 and later, this field is fixed at 3 characters.

('R' + 2 numbers).

'S' - Followed by 4 to 5 characters.

Restricted or Gross Flow Gain (G1).

(e.g. 2.00 = 2.00 x gain)

(e.g. 10.00 = 10.00 x gain)

In software revisions 3.8 and later, this field is fixed at 5 characters.

('S' + 4 numbers).

(e.g. 0971 = 9.71 x Gain)

'T' - Followed by 4 to 5 characters.

Reverse Flow Gain (G2).

(e.g. 2.00 = 2.00 x gain)

(e.g. 10.00 = 10.00 x gain)

In software revisions 3.8 and later, this field is fixed at 5 Characters.

('T' + 4 numbers).

(e.g. 0971 = 9.71 x gain)

'U' - Followed by 4 to 5 characters.

Direct Flow Gain (G3).

(e.g. 2.00 = 2.00 x gain)

(e.g. 10.00 = 10.00 x gain)

In software revisions 3.8 and later, this field is fixed at 5 characters.

('U' + 4 numbers).

(e.g. 0971 = 9.71 x gain)

'V' - Followed by 1 to 4 numbers.

Crossover #1 or Reverse Flow Crossover in millitorr.

(e.g. 10 = 10 millitorr)

(e.g. 200 = 200 millitorr)

(e.g. 9000 = 9000 millitorr)

In software revisions 3.8 and later, this field is fixed at 5 characters.

('V' + 4 numbers).

(e.g. 0300 = 300 millitorr)

'W' - Followed by 4 or 5 characters.

Stamped Leak Rate on Internal Calibrator in atm-cc/sec when state of leak detector is in any state except I-47. When the leak detector is in state I-47, this field will be the temperature compensated value of the internal calibrator. This value is what the leak detector is calibrating to when the internal calibrator is selected as the active calibrator.

(e.g. 5708 = 5.7 x 10⁻⁸ atm-cc/sec)

(e.g. 10010 = 10.0 x 10⁻¹⁰ atm-cc/sec)

In software revisions 3.8 and later, this field is fixed at 5 characters.

('W' + 4 numbers).

(e.g. 6304 = 6.3 x 10⁻⁴ atm-cc/sec. A mantissa of 10.0 will never be sent.)

'X' - Followed by 4 characters.

Stamped Temperature on Internal Calibrator in Degrees Celsius.

(e.g. 20.2 = 20.2 °C)

(e.g. 35.4 = 35.4 °C)

In software revisions 3.8 and later, this field is fixed at 3 characters.

('X' + 2 numbers).

(e.g. 25 = 25°C)

- 'Y' - Followed by 3 to 4 characters.
Fine Crossover Delay (D1) in Tenths of seconds.
(e.g. 0.1 = 0.1 seconds)
(e.g. 14.2 = 14.2 seconds)
In software revisions 3.8 and later, this field is fixed at 5 characters.
('Y' + 4 numbers).
(e.g. 0010 = 1.0 seconds)
- 'Z' - Followed by 3 to 4 characters.
Direct Rough Close Delay (D2) in Tenths of seconds.
(e.g. 7.2 = 7.2 seconds)
(e.g. 21.7 = 21.7 seconds)
In software revisions 3.8 and later, this field is fixed at 5 characters.
('Z' + 4 numbers).
(e.g. 0010 = 1.0 seconds)
- '[' - Followed by 3 to 4 characters.
Vent Valve Open Delay (D3) in Tenths of seconds.
(e.g. 1.0 = 1.0 seconds)
(e.g. 15.2 = 15.2 seconds)
In software revisions 3.8 and later, this field is fixed at 5 characters.
('[' + 4 numbers).
(e.g. 0010 = 1.0 seconds)
- '\' - Followed by 3 to 4 characters.
Vent Valve Close Delay (D4) in Tenths of seconds.
(e.g. 2.0 = 2.0 seconds)
(e.g. 10.3 = 10.3 seconds)
In software revisions 3.8 and later, this field is fixed at 5 characters.
('\' + 4 numbers).
(e.g. 0010 = 1.0 seconds)

'j' - Followed by 8 characters.

Filament #, Helium Mass, Gas Type, Pressure Units, FLASH Rev. and EPROM Rev.

Char#

1 — Filament Status ('1' = Filament #1, '2' = Filament #2)

2 — Helium Mass ('3' = He3, '4' = He4)

3 — Gas Type ('0' = Air Equiv. Units, '1' = Helium Units)

4 — Pressure Units ('0' = mTorr, '1' = mBar)

5 & 6 — FLASH Rev. ('33' = FLASH Rev. 3.3)

7 & 8 — EPROM Rev. ('15' = FLASH Rev. 1.5)

(e.g., j14003114 = Filament On, He4, Air Equiv. Units, mTorr, FLASH 3.1, and EPROM 1.4)

In software revisions 3.8 and later, this field is fixed at 9 characters.('j' + 9 numbers. It now appends ILD auto/manual mode status to the end).(e.g. j140031141 = Filament On, He4, Air Equiv. Units, mTorr, FLASH 3.1, EPROM 1.4, and ILD is in manual mode)

'^' - Followed by 6 characters.

For VIC's internal use only!

In software revisions 3.8 and later, this field is fixed at 5 characters.

('^' + 4 numbers).

'_' - Followed by 6 characters.

For VIC's internal use only!

In software revisions 3.8 and later, this field is fixed at 5 characters.

('_' + 4 numbers).

'"' - Followed by 3 to 5 characters.

Turbo Pump Speed in percent of full speed.

(e.g. 1.5 = 1.5% of full speed)

(e.g. 75.8 = 75.8% of full speed)

In software revisions 3.8 to 4.0, this field is fixed at 3 characters. An error will occur at 100% and will only show 10%.

('"' + 2 numbers).

(e.g. 25 = 25% of full speed)

In software revisions 4.1, this field is fixed at 4 characters.

('"' + 3 numbers).

(e.g. 025 = 25% of full speed)

(e.g. 100 = 100% of full speed)

'a' - Followed by 3 to 4 characters.

Minimum Gross Testing Time (D5) in Tenths of seconds.

(e.g. 0.1 = 0.1 seconds)

(e.g. 14.2 = 14.2 seconds)

In software revisions 3.8 and later, this field is fixed at 5 characters.

('a' + 4 numbers).

(e.g. 0100 = 10.0 seconds)

'b' - Followed by up to 8 characters.

Total Running Time in Hours.

(e.g. 1 = 1 hour)

(e.g. 32 = 32 hours)

In software revisions 3.8 and later, this field is fixed at 7 characters.

('b' + 6 numbers).

(e.g. 000047 = 47 hours)

'c' - Followed by 4 characters.

Minimum Roughing Time (D6) in Tenths of seconds.

This field did not exist In software revisions prior to Rev. 3.8.

(e.g. 0001 = 0.1 seconds)

(e.g. 0142 = 14.2 seconds)

'd' - Followed by 4 numbers.

Reverse Rough Close Delay (D7) in Tenths of seconds.

(e.g. 0001 = 0.1 seconds)

(e.g. 0142 = 14.2 seconds)

This field did not exist In the serial stream in software revisions prior to

Rev. 4.1. However, is was present on the MS-60 user panel and functioned properly in software Revisions 3.9 and later.

'e' - Followed by 3 numbers.

Profile Switch Setting (0 = 255)

(e.g. 001)

(e.g. 128)

This field did not exist In the serial stream in software revisions prior to Rev. 4.1.

'f' - Followed by 3 numbers.

Revision Switch Setting (0 = 255)

(e.g. 001)

(e.g. 128)

This field did not exist In the serial stream in software revisions prior to Rev. 4.1.

'g' - Followed by 6 numbers. (first 5 are the leak rate and the last is reject status). Previous Test Final Leak Rate Value & Reject Status measured in atm-cc/sec or mbar-l/sec. See 'H' for reject status values. This is the leak rate value and reject status of the previous leak test cycle just prior to the termination of the test. It is used for data logging.

(e.g. 057082 = 5.7 x 10⁻⁸ atm-cc/sec & Accept or Pass)

(e.g. 100103 = 10.0 x 10⁻¹⁰ atm-cc/sec & Reject or Fail)

This field did not exist In the serial stream in software revisions prior to Rev. 4.2.

All revisions prior to Rev 4.0 transmit the serial stream as follows:

Packets 'C' through 'I' are sent all the time. Packets 'A' and 'B' are only sent when necessary. Packets 'L' and 'N' are send every third time after packet 'I'. Packets 'J', 'K', and 'O' through 'g' are sent every 33 times after packets 'L' and 'N'.

Revision 4.0 has added the following options for serial stream transmission:

1. The user can select individual packet(s) to be sent all the time or on demand.
2. On power-up the MS-60 will default to the old MS-60 compatibility mode. All packets will eventually be sent but they will be sent using the old format. If the MS-60 is set for ILD mode, then no packets will be sent on start-up.
3. The user can terminate each packet with either a carriage return or a line feed. The default will be no terminators. The terminator instruction will be 'T0Z' for no termination. 'T1Z' will enable the carriage return as the terminator. 'T2Z' will enable the line feed as the terminator. Each command will override the previous.
4. The default packet set will be all packets. If a smaller number of packets is desired, then the array can either be cleared or a specific packet can be eliminated from the set. The clear instruction is 'E0Z'. If the MS-60 receives this command, only the 'A' packet will be sent. To reset the stream to all packets, the command 'E1Z' should be sent. To stop a specific packet from being sent, the 'Gab0Z' command can be sent to the MS-50 where 'ab' is the packet number (i.e. if 'ab' = '02', then the 2nd packet or 'C' packet will never be sent). To add a packet to the stream, the 'Gab1Z' command must be sent (i.e. if 'ab' = '17', then the 17th packet or 'R' packet will now be sent in the stream). NOTE: The '00' or 'A' packet will always be included in the stream. This will force all serial stream lengths to be the same.
5. To cause the stream to be sent using the original MS-60 format, then send the 'I1Z' instruction. 'I0Z' will terminate the stream and revert back to the original format.
6. 'PxyZ' is the single packet query instruction. This will send only the 'xy'th packet and no others (if x=2 and y=3, the 23rd packet will be sent). Issuing this instruction will cause the serial stream to stop after its last packet. If the user has 5 packets being sent, the array will not be cleared, but if they were being sent out continuously, this would stop. Once the stream stops, then the desired packet 'xy' will follow and nothing more will be sent.
7. 'Q1Z' is the multiple packet query instruction. This will only send the packet(s) in the array once. If packets 'C', 'D', and 'G' are in the array, then all three packets will be sent and nothing more. If the packets were being sent out continuously, the serial stream will stop with this last burst of packets.
8. 'S1Z' will cause packet(s) to be sent continuously. 'S0Z' will halt packet transmission.

Note: The packets are transmitted in the following order:

PACKET #	PACKET LETTER	PACKET #	PACKET LETTER
00	A	19	U
01	B	20	V
02	C	21	W
03	D	22	X
04	E	23	Y
05	F	24	Z
06	G	25	[
07	H	26	\
08	I	27]
09	L	28	^
10	N	29	_ (underscore)
11	J	30	' (left single quote)
Packet #	Packet Letter	Packet #	Packet Letter
12	K	31	a
13	O	32	b
14	P	33	c
15	Q	34	d
16	R	35	e
17	S	36	f
18	T	37	g

Prior to software revision 3.8, the MS-60 would start transmitting data through its RS-232 port whenever it detected a specific logic level on its DSR pin. This, however, had to be changed because certain types of computers caused the MS-60 to transmit data even if the computer was turned off. This would cause the MS-60 to 'lock-up' after a short period of time. The remote computer now has to issue a command to the MS-60 before it will transmit any data (MS-60's that are built as ILDs always transmit data). This command is made up of 3 ASCII characters. 'S1Z' will command the MS-60 to start transmitting data. 'S0Z' will command the MS-60 to stop transmitting data. This method is not to be used for RS-232 hand-shaking.

The remote PC or controller has the ability to send many different commands to the MS-60. There are two basic types of commands. One command is equivalent to pressing a key on the MS-60's user panel and the other type is equivalent to a parameter change. The key press commands allow for remote control and the parameter changing commands allow the remote computer or controller to change either the system delay, testing crossover pressures, indicate ILD automatic or manual mode, or change the REJECT set point.

Most remote commands will be sent to control normal operation/cycling of the MS-60 leak detector. Normal starting and stopping of test cycles will be controlled remotely. If the remote computer is making leak test decisions, such as how long to test a specific part, the software must be aware that accurate leak rates only occur in the GROSS, REVERSE, DIRECT and SNIFFER testing states. Roughing states do not test for the presence of helium and rough close delay states corrupt the flow of helium by pumping some of the helium away with the rough pump. Leak test decisions should not be made in these states. Also, during normal test cycles, if the high vacuum pressure exceeds 5.0×10^{-4} Torr, the filament is turned OFF but the leak test cycle is not terminated. This is called the PRESSURE BURST CLEANUP mode. The filament on/off flag sent with the 'L' packet is one method of monitoring this state. However, if using the old compatible serial stream format, monitoring the filament current will give the remote computer a faster response to this situation. Filament on/off status is sent on every third transmission of the filament current as mentioned above. The filament will be turned back on every 10 seconds to check the high vacuum pressure. If the pressure is still too high, the filament will shut itself back off, otherwise it will remain on and testing will continue.

If the remote computer or controller wants to terminate a test cycle based upon a certain length of time in testing mode, the time spent in PRESSURE BURST CLEANUP should not be included in this time. Testing parts for helium does not occur at these times. Also, if the remote computer terminates the test because of an ACCEPT or REJECT indication, do not terminate the test cycle when the reject status is INVALID. This will not harm the MS-60, but will not give a positive ACCEPT or REJECT signal.

Below is a list of all possible remote PC commands that may be sent to the MS-60 and do not control the format of the serial stream. All commands begin with one of these letters ['D', 'F', 'K', 'M', 'R'] and are all terminated by the letter 'Z'. The numbers in the middle make up the desired command.

All 'keypress commands' start with the letter 'K' and end with the letter 'Z'. Each keypress command works in exactly the same fashion as if an operator had pressed the corresponding key on the leak detector. There are 29 different key-press commands, each requiring 2 numbers, as follows:

Command #

- 00 — Start Button**
- 01 — Vent Button**
- 02 — Select Up**
- 03 — Select Down**
- 04 — Set Right**
- 05 — Set Left**
- 06 — Calibrator Valve Button**
- 07 — Ext. Rough Valve Button**
- 08 — Fine Valve Button**
- 09 — Foreline Valve Button**
- 10 — Gross Valve Button**
- 11 — Purge Valve Button**
- 12 — Rough Valve Button**
- 13 — Sniffer Valve Button**
- 14 — Vent Valve Button**
- 15 — System Vent Command (Can only be sent in 'STANDBY' states)**
- 16 — Filament ON/OFF button**
- 17 — Filament Button**
- 18 — Helium/Air Units Button**
- 19 — Helium Mass 3/4 Button**
- 20 — Cal-Check Button**
- 21 — Calibrate (CAL) Button**
- 22 — Tune Button**
- 23 — Auto/Manual Ranging Button**
- 24 — Range Up Button**
- 25 — Range Down Button**
- 26 — Volume Up Button**
- 27 — Volume Down Button**
- 28 — Zero Button**

To send a command to Auto-Zero the testport helium background, the remote PC or controller must send the following command string:

'K28Z'

To send a command to start a leak test cycle, the following string must be sent to the MS-60:

'K00Z'

To set one of the 6 system delays, the PC must send a command that starts with a 'D', followed by 5 numbers, and ends with a 'Z'. The first number is the delay number [1, 2, 3, 4, 5, 6, 7] and the last 4 numbers make up the desired delay in tenths of a second.

Software revisions prior to Rev. 3.5 only had 4 delays. Software revisions 3.6 and 3.7 had 5 delays. All revisions prior to Rev.3.8 only used 3 numbers for the delay time, giving a maximum delay time of 99.9 seconds. Now the maximum delay time can be set to 999.9 seconds.

For a FINE CROSSOVER DELAY (Delay #1) of 2.0 seconds, the following string must be sent:
'D10020Z'

For a DIRECT ROUGH CLOSE DELAY (Delay #2) of 0.1 seconds, the following string must be sent:
'D20001Z'

For a VENT OPEN DELAY (Delay #3) of 5.0 seconds, the following string must be sent:
'D30050Z'

For a VENT CLOSE DELAY (Delay #4) of 12.5 seconds, the following string must be sent:
'D40125Z'

For a MINIMUM GROSS LEAK TEST TIME (Delay #5) of 7.0 seconds, the following string must be sent:
'D50070Z'

For a MINIMUM ROUGHING TIME (Delay #6) of 20.0 seconds, the following string must be sent:
'D60200Z'

For a REVERSE ROUGH CLOSE DELAY (Delay #7) of 0.1 seconds, the following string must be sent:
'D20001Z'

If an attempt is made to change a delay to an invalid value, the MS-60 will clip the value to either its upper or lower limits and will send back an error indication in its stream of data ('A1'). Its new value will show up in the appropriate portion of the data stream.

To set one of the crossovers, either #1 or #2, the PC must send a command that starts with an 'F', followed by 5 numbers, and ends with a 'Z'. The first number is the crossover number. '1' for crossover #1 and '2' for crossover #2. The next 4 numbers make up the desired crossover pressure in millitorr.

For a REVERSE CROSSOVER (#1) of 350 millitorr, the following string must be sent:
'F10350Z'

For a DIRECT CROSSOVER (#2) of 25 millitorr, the following string must be sent:
'F20025Z'

If an attempt is made to change a crossover to an invalid value, the MS-60 will clip the value to either its upper or lower limits and will send back an error indication in its stream of data ('A1'). Its new value will show up in the appropriate portion of the data stream.

For use in an MS-60 ILD, the remote PC can enable or disable the 'START' button on the MS-60's user panel. This happens during normal use of the MS-60 ILD and is done by sending a command that starts with the letter 'M', is followed by a '0' and is terminated with the letter 'Z'. This command would disable the 'START' button and place the MS-60 ILD into 'Automatic Start Mode'. If the remote PC would like to enable the 'START' button and place the MS-60 ILD into 'Manual Start Mode', the '0' between the 'M' and the 'Z' would be replaced by the number '1'.

'M0Z' = Automatic Start Mode

'M1Z' = Manual Start Mode

The REJECT set point change command starts with an 'R', has 4 numbers, and is ended with a 'Z'. The first two numbers make up the reject mantissa and the last two make up the reject exponent. Here the exponent is assumed to be negative.

For a REJECT POINT of 2.0×10^{-8} , the following string must be sent to the MS-60:
'R2008Z'

For a REJECT POINT of 5.0×10^{-10} , the following string must be sent:
'R5010Z'

For a REJECT POINT of 6.3×10^{-7} , the following string must be sent:
'R6307Z'

If an attempt is made to change the REJECT set point to an invalid value, the MS-60 will clip the value to either its upper or lower limits and will send back an error indication in its stream of data ('A1'). Its new value will show up in the appropriate portion of the data stream.

Please Note: The state numbers below are for software revisions 3.7 and earlier. They will differ slightly for revision 3.8 and later.

As an example, let's go through the sequence of a remotely controlled leak test cycle. First we monitor the present state packet 'I'. We wait for the MS-60 to power-up and go into the standby states 4, 5, 11, or 12. At this time we can check the crossover points, the delays, and the REJECT set point to make sure they are appropriate for the part being tested. If they are not correct, we can change them using the appropriate commands. We will set the Reverse crossover pressure to 200 millitorr by sending the string of 'F10200Z' because this is crossover #1. We will set the REJECT set point to 2.0×10^{-8} atm-cc/sec by sending the string of 'R2008Z'. After we send each of the following strings, we must monitor the MS-60 data stream to verify that both an error ('A1') has not occurred and that the crossover and reject values have been updated. Once this has been completed, we can now start the test cycle. To start the test cycle we must send the string of 'K00Z'. At this time we monitor the data stream to make sure an error ('A1') was not generated and that the leak detector has changed to the ROUGHING TESTPORT state 6 or 13. After this

happens, we still monitor the present state and the reject status. Once the reject status changes to either an ACCEPT or a REJECT, we can terminate the test cycle by sending the string 'K01Z'. At this time the present state will change to 4, 5, 11, or 12 and we will need to vent the testport to enable the operator to remove the test object. For this we need to send the string 'K15Z'.

Now the sequence can be repeated for more test objects.

If we want to SNIFF test, the sequence wouldn't change except for the present state values. First we would have to change the present state from a Vacuum Mode standby to a Sniffer Mode standby by sending the string 'K13Z' when the MS-60 was in one of the vacuum mode standby states of 4, 5, 11, or 12. This will cause the MS-60 to change to either state 18, 19, 22, or 23. If the leak detector is set for manual ranging, the Sniffer Mode standby states would be 22 or 23. Once the correct standby state has been entered, we can continue with the normal operational sequence.

During a test cycle, if we wanted to change from manual ranging to automatic ranging or vice-versa, all we have to do is send the string 'K23Z' which is equivalent to pressing the Auto/Manual Ranging Button on the MS-60's user panel.

The RS-232 data format is:

- a. 8 Data Bits
- b. Even Parity
- c. 9600 Baud
- d. 1 Stop Bit

Hand-shaking is done by using a NULL MODEM adapter or equivalent and observing the following rules:

1. The MS-60 will start sending the data stream when it is issued the appropriate command ('S1Z').
2. The MS-60 will not transmit when its CTS line (RTS line of remote PC) is driven low. This should only be done during serial port interrupts on the remote PC.
3. The remote PC must not send data to the MS-60 when the MS-60 has driven its RTS line low (CTS line of PC remote).

Point To Point Wiring for MS-60 and Remote Computer:

NOTE:

A standard NULL MODEM cable will work or a straight through RS-232 cable with a NULL MODEM adapter can be used.

The MS-60 9-pin connector is designated RS232 on the rear of the leak detector.

MS-60 9-pin Connector ———> Computer 25-Pin Connector

1, 6	20
2	2
3	3
4	6,8
5	7
7	5
8	4
9 not connected	22

MS-60 9-pin Connector ———> Computer 9-Pin Connector

1, 6	4
2	3
3	2
4	6,1
5	5
7	8
8	7
9 not connected	9

APPENDIX E - Profile And Revision Switch Positions For VIC MS-60 Series Leak Detectors

Profile Switch:

- 8 Operation Mode (Normal = UP, ILD = DOWN, Software Rev. 3.4 and later)
- 7 Roughing Pump System (Wet = UP, Dry = DOWN, Software Rev. 3.8 and later)
- 6 Reverse Flow (Enabled = UP, Disabled = DOWN, Software Rev. 4.1 and later)
- 5 Speaker Triggered from Reject Pt. (Disabled = UP, Enabled = DOWN, Software Rev. 4.1 and later)
- 4 Auto-Tune Alert: (Disable = Up, Enabled = Down – Software Rev. 4.8 or later)
- 3 Automatic Auto-Tune on Power-Up: (Disable = Up, Enabled = Down – Software Rev. 4.8 or later)
- 2 Direct Flow: (Disable = Up, Enabled = Down – Software Rev. 5.1 or later)
- 1 Pump Select: (Edwards = DOWN, Pfeiffer = UP – Rev 7.2 or later)

Revision Switch:

- 8 RS232 Leak Rate Mantissa: (X.X = UP, X.XX = DOWN – Software Rev. 7.2 or later)
- 7 Tracer Gas Clean-Up: (Disable = Up, Enabled = Down – Software Rev. 5.9 or later)
- 6 ILD Serial Stream Requirements (New Style = UP, Old Style = DOWN, Software Rev. 4.0 and later)
- 6 Alternate function – When ILD mode is not selected switch 6 can enable or disable the reject output time delay.
Delay Enabled = switch UP, Disabled = switch Down – Rev. 7.5 or later.
- 5 Disable Parity in Serial Stream (8-N-1)
(8-E-1 = Up, 8-N-1 = Down---Software Rev. 4.0 or Later)
- 4 External Vent Assist: (Disable = Up, Enabled = Down – Software Rev. 5.3 or later)
- 3 Extend Gross Range to -5: (Disable = Up, Enabled = Down – Software Rev. 5.6 or later)
- 2 Gross Mode Only: (Disable = Up, Enabled = Down – Software Rev. 4.8 or later)
- 1 Used by VIC Test Personnel Only

MS-60 Quick Reference

This section contains quick reference charts for the following functions and displays:

- The User/Control Panel
- The Service Panel
- The Alphanumeric Display
- MS-60 Error Codes
- Periodic Maintenance Functions

A more complete description of these functions is contained within the main body of the MS-60 Operations Manual.

Quick Reference - MS-60 User Control Panel

Function/Key	Standard Mode	Service Mode
Leak Rate Bar Graph	Displays mantissa of leak rate.	Displays mantissa of leak rate, including system background.
Numeric Exponent Display	Displays exponent of leak rate. Displays "EE" if error occurs.	Displays exponent of leak rate.
Accept LED	Lights during testing if leak rate is less than the user-set Reject Point and the MS-60 is in or below the range of the Reject Point.	Disabled.
Reject LED	Lights during testing if the leak rate is greater than or equal to the user-set Reject Point.	Disabled.
std cc/sec, mbar l/sec, Pa M ³ /sec	Indicator for selected leak rate designation.	Indicator for selected leak rate designation.
Test Port	Displays test port pressure on bar graph.	Displays test port pressure.
Auto/Manual Ranging	Selects either automatic or manual ranging during testing.	Disabled.
Ranging Up/Down	Changes selected leak rate range for testing either up or down. Pressing one of the arrow keys while in Auto Ranging mode will switch MS-60 to Manual Ranging.	Changes selected leak rate range for testing either up or down.
Audio Up/Down	Increases or decreases volume of speaker and headphone output.	Increases or decreases volume of speaker and headphone output. Also used to set time and date if selected on alphanumeric display.
Zero (AZ ³)	3 modes available, Normal, Spray and Hold. "Zeros" out any helium being measured. Only active during testing. Limits ranging to two ranges below zeroed range. Cancelled at the end of the test cycle.	Tuns turbo pump on or off. LED indicates status.
Sniff Mode LED	Indicates that MS-60 has been switched to Sniff mode.	Opens and closes the sniff valve.
Start Switch	Used to start a pump/test cycle. Pressing a second time will interrupt the test cycle without the chance of venting. Switch is illuminated when test cycle is initiated.	Disabled.
Vent Switch	Used to stop a test cycle and to vent the test port. Pressing momentarily stops cycle. Pressing and holding vents test port.	Disabled.
Ready LED	Indicates that MS-60 is in the Standby mode and is ready for the next test.	Disabled.

Quick Reference - MS-60 Service Panel

Function/Key	Standard Mode	Service Mode
Service LED	Off	On
Cal Valve	Disabled	Opens/Shuts Cal Valve.
Ext Rough	Disabled	Opens/Shuts External Rough Valve.
Fine	Disabled	Opens/Shuts Fine Valve.
Gross	Disabled	Opens/Shuts Gross Valve.
Purge	Opens/Shuts Purge Valve (Standby mode only).	Opens/Shuts Purge Valve.
Rough	Disabled	Opens/Shuts Rough Valve.
Sniff	Switches MS-60 to Sniff mode.	Opens/Shuts Sniff Valve.
Vent	Disabled	Opens/Shuts Vent Valve.
Fil On/Off	Toggles filament on or off, can only be turned on if high vacuum pressure is good; cannot be turned off during leak testing.	Toggles filament on or off (totally unprotected).
Fil 1/2	Selects filament 1 or 2; Green LED indicates good filament; Red LED indicates bad filament.	Selects filament 1 or 2; Green LED indicates good filament; Red LED indicates bad filament.
Helium/Air	Disabled	Switches between helium and air equivalent leak rate units.
Mass 3/4	Disabled	Switches accelerating voltage in mass spectrometer from Mass 3 to Mass 4.
Cal Check	Performs check of calibration using internal helium leak standard.	Disabled
Cal	Adjusts amplifier gain to calibrate leak rate. Only available after Cal Check.	Disabled
Tune	Performs full automatic tune and calibration demand..	Disabled
Select	Chooses which function is shown on alphanumeric display.	Chooses which function is shown on alphanumeric display.
Set	Sets value for those functions on alphanumeric display that can be changed.	Sets value for those functions on alphanumeric display that can be changed.

Quick Reference - MS-60 Service Panel Alphanumeric Display

- Choose function using "Select" switches
- Set value using "Set" switches

Function/Key	Standard Mode	Service Mode
Amp Gain	<p>G1 is Gross Mode Gain G2 is Reverse Mode Gain G3 is Direct Flow Gain G4 is Sniff Gain G5 is Power Sniff Gain</p> <p>G2 & G3 are set by computer.</p> <p>G2 & G3 gains cannot be changed in Standard Mode. G1, G4 & G5 may be changed in Standard Mode during leak testing in the Gross Mode or Sniff Modes. Can change any gain in Service Mode.</p>	Changing G2 & G3 will uncalibrate system. G1 must be set by user.
Anode Voltage	<p>Displays accelerating voltage of mass spec.</p> <p>Holding Set switches while leak testing will cause peak to "de-scan" $\approx 30V$.</p>	Display accelerating voltage of mass spec. Press Set switches to change anode voltage in one volt steps.
Cal Temp	Shows current temperature of internal Calibrator.	Used to set the temperature at which the calibrator was calibrated. Should only be changed if the calibrator is changed.
Crossover 1	User settable crossover pressure for reverse flow mode. Max: 9600 mTorr.	Same as Standard mode.
Crossover 2	User settable crossover pressure for direct flow mode. Max: 150mTorr.	Same as Standard mode.
D1	Fine crossover delay.	Shows software revision in flash eprom.
D2	Rough close delay.	Shows software revision in eprom.
D3	Vent delay.	Shows high collector range electrical offset.
D4	Vent duration.	Shows low collector range electrical offset.
D5	Minimum Gross testing time.	Same as Standard mode.
D6	Minimum Rough time.	Same as Standard mode.

Quick Reference - MS-60 Service Panel Alphanumeric Display (cont.)

Function/Key	Standard Mode	Service Mode
D7	Reverse Rough Close delay (used on units with external roughing option only).	Same as Standard mode.
Emission	Displays filament emission current in milliamps (mA). Properly operating filament has emission of 5mA.	Same as Standard mode.
Error Code	Shows any errors present. Codes are automatically displayed if errors occur. If no errors detected displays NONE.	Displays current date. Date can be changed using the Set and Audio keys.
Fil Amps	Displays filament supply current in DC amps. Maximum: 6.0 amps.	Same as Standard mode.
Foreline	Displays foreline pressure in mTorr or mBar.	Same as Standard mode.
High Vacuum	Displays high vacuum pressure in Torr or Bar. If filament is off, hi vac display shows OFF. During standby, system will periodically check offsets (while display shows MS-60)	Same as Standard mode.
Internal Cal	Displays current temperature compensated value of internal calibrator.	Used to program leak rate value of calibrator from certificate. Should only be changed if calibrator is changed.
Leak Rate	Digital display of leak rate.	Same as Standard mode.
Reject Point	Use3d to set leak rate reject point.	Shows percent of full speed of turbo pump.
Test Port	Digital display of test port pressure in mTorr or mBar. Select units feature switch on back of C board.	Same as Standard mode.
Total Hours	Display total number of hours that unit has been running.	Displays current time. Time can be changed using Set and Audio keys.

Quick Reference - MS-60 Error Codes

#	Description	Action
01	Foreline max error	Foreline has exceeded 8000 mTorr. All valves except foreline shut, turbo shuts down. Will restart when foreline recovers.
02	Hi Vac too high	Hi vac above 5×10^{-4} Torr. Shuts off filament, then turns filament on every ten seconds. If it does not "catch" after several tries, shuts off unit.
04	Auto Zero error	User has attempted to zero out leak beyond the capability of the unit.
05	Foreline Test error	Foreline pressure has exceeded 7000 mTorr (probably during test, after reverse crossover). Aborts test cycle, goes into standby mode.
07	High Voltage error	High voltage supply from B board to Source has failed. System shuts off filament, all valves, and pump(s).
08	Filament current low	Filament current has dropped below 1 ampere. The filament should be replaced.
09	Temp too high	Temperature sensor is reading above 60°C . Fan may have failed. Sensor may be defective or unplugged.
10	Emission too low	Emission has dropped below 4.7 mA. If occurs during Cal Check or Tune, will abort procedure.
11	PC remote error	Problem with remote PC. System will still operate properly without PC.
13	Rough time exceeded	?During Cal Check or Tune, unit can not pump down to crossover within five (5) minutes.
18	Printer error	Printer is not responding
20	Gain too low error	One of the system gains (G2 or G3) has been set below allowable limits during a Tune or Calibration cycle.
22	Temp too low	Temperature is below 10°C . System shuts down.
23	Cannot Peak Tune	System computer cannot find helium peak.
24	Gain too high	One of the system gains (G2, Reverse, g3, Fine) is at the maximum (10). Error will continue to be displayed unit is retuned.
26	Turbo fail	The turbo pump or controller has failed. System is shut down.
30	HH remote error	Transmission error between main unit and hand held remote control.
33	Repeller fail	Discontinuity in circuitry for mass spec source repeller. System will continue to operate, but testing will not be allowed.

Quick Reference - MS-60 Recommended Periodic Maintenance

Description	Frequency	See Manual Section
Check Calibration (Cal Check)	Twice per shift (minimum)	4.3
Auto Tune Mass Spectrometer	As Required (at least weekly)	4.3
Grease Test Port O-Ring	Weekly	4.2.1
Check Air Filters	Weekly	4.2.2
Check Oil Level in Internal (and optional External) Rotary Vane Mechanical Pump(s)	Monthly	4.2.3
Check Exhaust Filter on Internal Rotary Vane Mechanical Pump	Monthly	4.2.4
Change Oil in Internal (and optional External) Rotary Vane Mechanical Pump(s)	Semi-Annually	4.2.5
Recalibrate Internal Leak Standard	Annually	4.2.7